

TM 11-6625-1636-14

TECHNICAL MANUAL

**OPERATOR'S ORGANIZATIONAL, DIRECT SUPPORT,
AND GENERAL SUPPORT MAINTENANCE MANUAL**

**TEST SET, ANTENNA COUPLER
AN/ARM-109
NSN 6625-00-903-6385**

HEADQUARTERS, DEPARTMENT OF THE ARMY

JUNE 1976

Warning

HIGH VOLTAGE is used in the operation of this equipment. DEATH ON CONTACT may result if personnel fail to observe safety precautions. Learn the areas containing high voltage in each piece of equipment. Be careful not to contact high voltage connections when installing or opening this equipment. Before working inside the equipment, turn power off and ground points of high potential before touching them.

Change }
No. 1 }

**HEADQUARTERS
DEPARTMENT OF THE ARMY
WASHINGTON, DC, 16 September 1980**

**Operator's, Organizational, Direct Support
and General Support Maintenance Manual
TEST SET, ANTENNA COUPLER
AN/ARM-109
(NSN 6625-00-903-6385)**

This change current as of 1 September 1979

TM 11-6625-1636-14, 10 June 1976, is changed as follows:

1. Remove old pages and insert new pages as indicated below.
2. New or changed material is indicated by a vertical bar in the margin of the page.

Remove Pages	Insert Pages
i and ii	i and ii
1-0 through 1-3	1-0 through 1-3
2-1 and 2-2	2-1 and 2-2
2-5	2-5 through 2-8
3-1 through 3-6	3-1 through 3-6
6-15 and 6-16	6-15 through 6-16.1
FO-5	None

3. File this change sheet in front of the publication for reference purposes.

By Order of the Secretary of the Army:

Official:

E. C. MEYER
*General, United States Army
Chief of Staff*

J. C. PENNINGTON
*Major General, United States Army
The Adjutant General*

Distribution:

ACTIVE ARMY, USAR, ARNG: To be distributed in accordance with DA Form 12-36A, Organizational Maintenance requirements for AN/ARM-109.

Technical Manual }
 No. 11-6625-1636-14 }

**HEADQUARTERS
 DEPARTMENT OF THE ARMY
 WASHINGTON, DC, 10 June 1976**

**OPERATOR'S, ORGANIZATIONAL, DIRECT SUPPORT, GENERAL SUPPORT
 MAINTENANCE MANUAL**

TEST SET, ANTENNA COUPLER

AN/ARM-109

NSN 6625-00-903-6385

	Paragraph	Page
Chapter 1. INTRODUCTION		
Section I. General		
Scope	1-1	1-1
Indexes of publications	1-2	1-1
Forms and records	1-3	1-1
Recommendation for maintenance publications improvements	1-4	1-1
Military nomenclature and commercial designations	1-5	1-1
Section II. Description and data		
Description	1-6	1-2
Tabulated data	1-7	1-3
Chapter 2. SERVICE UPON RECEIPT OF EQUIPMENT AND INSTALLATION		
Service upon receipt		
Unpacking and inspecting	2-1	2-1
Installation		
Preinstallation test	2-2	2-1
Initial adjustments	2-3	2-2
Chapter 3. OPERATING INSTRUCTIONS		
General	3-1	3-1
Operating controls	3-2	3-1
Operating procedures	3-3	3-1
Chapter 4. ORGANIZATIONAL MAINTENANCE		
Section I. General		
Scope of maintenance	4-1	4-1
Tools, test equipment and materials		4-1
Section II. Preventive maintenance procedures		
Preventive maintenance	4-3	4-1
Preventive maintenance check and services	4-4	4-1
Cleaning	4-5	4-2
Chapter 5. FUNCTIONING OF EQUIPMENT		
Electronic functioning	5-1	5-1
878L-15 Antenna Coupler Control Tester, circuit analysis	5-2	5-1
878L-16 Electronic Control Amplifier Tester, circuit analysis	5-3	5-1
878L-17 Discriminator Tester, circuit analysis	5-4	5-2
Chapter 6. GENERAL SUPPORT MAINTENANCE		
Troubleshooting data	6-1	6-1
878L-15 Antenna Coupler Control Tester	6-2	6-2
878L-16 Electronic Control Amplifier Tester	6-3	6-7
878L-17 Discriminator Tester	6-4	6-16.1
Troubleshooting and repair of transistorized circuits	6-5	6-20
Cleaning of dismantled module testers	6-6	6-20
Cleaning procedures	6-7	6-21
Inspection of mechanical parts	6-8	6-22
Inspection of electrical or electronic components	6-9	6-23
Appendix A. REFERENCES		A-1
Appendix B. BASIC ISSUE ITEMS LIST AND ITEMS INSTALLED OR AUTHORIZED LIST (NOT APPLICABLE)		
Appendix C. MAINTENANCE ALLOCATION		
Section I. Introduction		C-1
Section II. Maintenance allocation chart		C-3

*This manual supersedes so much of TM 11-6625-1636-15, 15 June 1967, as pertains to operator's, organizational, direct support, and general support maintenance.

LIST OF ILLUSTRATIONS

Figure number		Page
1-1.	Test Set, Antenna Coupler AN/ARM-109	1-0
2-1.	Test Set, Antenna Coupler Control TS-2353/ARM-109	2-3
2-2.	Test Set, Electronic Control Amplifier TS-2354/ARM-109 Outline and Mounting Dimensions	2-3
2-3.	Discriminator Tester TS-2352/ARM-109 Outline and Mounting Dimensions	2-4
2-4.	Test Set 980H-1 Outline and Mounting Dimensions	2-5
2-5.	Test Set 980H-1 Power Panel, Schematic Diagram	2-6
2-6.	Power Panel Special Cable Assembly W1, Schematic Diagram	2-6
2-7.	878L-15 Special Cable Assembly W2, Schematic Diagram	2-7
2-8.	878L-16 Special Cable Assembly W3, Schematic Diagram	2-8
2-9.	878L-17 Special Cable Assembly W4, Schematic Diagram	2-8
3-1.	TS-2353/ARM-109, Operating Controls Identification	3-1
3-2.	TS-2354/ARM-109 Operating Controls Identification	3-2
3-3.	TS-2352/ARM-109 Operating Controls Identification	3-2
3-4.	AN/ARM-109 Power Panel, Operating Controls Identification	3-6
FO-1.	Resistor, capacitor, and inductor color codes	Fold-out
FO-2.1.	Antenna Coupler Control Tester 878L-15, Schematic Diagram (Sheet 1 of 2)	Fold-out
FO-2.2.	Antenna Coupler Control Tester 878L-15, Schematic Diagram (Sheet 2 of 2)	Fold-out
FO-3.	Electronic Control Amplifier Tester 878L-16, Schematic Diagram	Fold-out
FO-4.	Discriminator Tester 878L-17, Schematic Diagram	Fold-out

LIST OF TABLES

Number	<i>Title</i>	Page
1-1.	Official Military Nomenclature and Commercial Designations	1-2
1-2.	Items Comprising AN/ARM-109	1-2
1-3.	Equipment Required But Not Supplied	1-3
2-1.	Lighting Sequence of Program Indicators for 878L-15	2-1
2-2.	Lighting Sequence of Program Indicators for 878L-16	2-2
3-1.	Description of 878L-15 Operating Controls	3-3
3-2.	Description of 878L-16 Operating Controls	3-3
3-3.	Description of 878L-17 Operating Controls	3-5
3-4.	Description of Power Panel Operating Controls	3-6
6-1.	Test Equipment Required	6-2
6-2.	Antenna Coupler Control Tester 878L-15 Minimum Performance Test	6-3
6-3.	Antenna Coupler Control Tester 878L-15, Diode Matrix Ground Test	6-4
6-4.	Antenna Coupler Control Tester 878L-15, Diode Matrix 28-VDC Test	6-5
6-5.	Antenna Coupler Control Tester 878L-15, Troubleshooting Chart	6-5
6-6.	Electronic Control Amplifier Tester 878L-16, Minimum Performance Test	6-8
6-7.	Electronic Control Amplifier Tester 878L-16, Troubleshooting Chart	6-10
6-8.	Discriminator Tester 878L-17, Minimum Performance Test	6-17
6-9.	Discriminator Tester 878L-17, Troubleshooting Chart	6-18
6-10.	Typical Electronic Control Amplifier Transistor Voltage	6-20
6-11.	Inspection of Fixed Capacitors	6-23

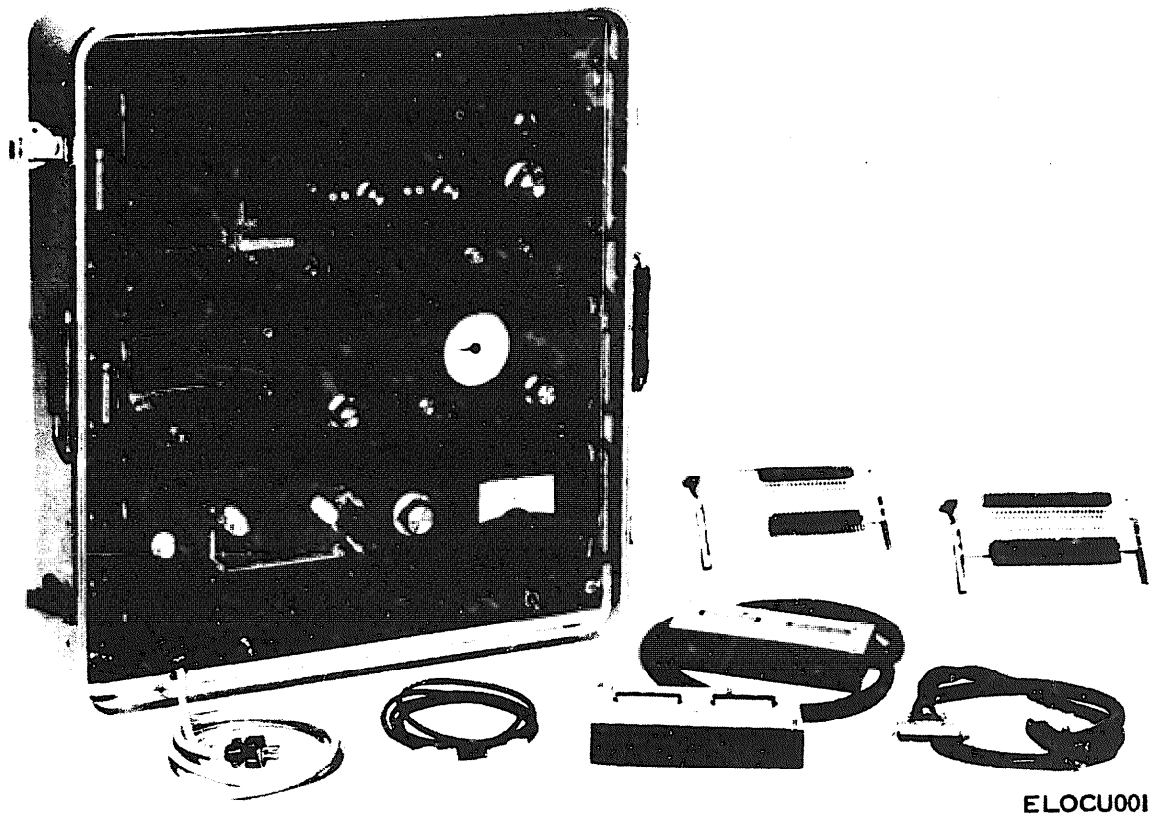

Figure 1-1. Test Set. Antenna Coupler AN/ARM-109.

CHAPTER 1

INTRODUCTION

Section I. GENERAL DESCRIPTION

1-1. Scope

a. This manual provides instructions for the installation, operation, testing and mechanical overhaul of the 878L-15 Coupler Control Tester, the 878L-16 Electronic Control Amplifier Tester, and the 878L-17 Discriminator Tester. When the testers are referenced collectively, they will be referred to as the 878L-15/16/17 module tester, Test Set Antenna Coupler AN/ARM-189. The test set **completely checks** Antenna Coupler CU-1658/A (Collins 490T-1). **This manual is** presented in the following functional sections: **general description, installation, operation, principles** of operation, maintenance, parts list, and illustrations.

b. The lowest level at which maintenance, other than preventive maintenance, is authorized, is **general** support; therefore, there are no direct **support** maintenance procedures.

1-2. Indexes of Publication

a. DA Pam 310-4. Refer to the latest DA Pam 310-4 to determine whether there are new editions, **changes**, or additional publications pertaining to the equipment.

b. DA Pam 310-7. Refer to **DA Pam 310-7 to determine** whether there are **Modification Work-Orders (MWO's) pertaining to the equipment.**

1-3. Maintenance Forms, Records, and Reports

a. Reports of Maintenance and Unsatisfactory Equipment. Department of the Army forms and

procedures used for equipment maintenance will be those prescribed by **TM 38-750**, The Army Maintenance Management System.

b. Report of Packaging and Handling Deficiencies Fill out and forward DD Form 6 (Packaging Improvement Report) as prescribed in AR 735-11-2/NAVSUPINST 4440.127E/AFR 400-54/MCO 4430.3E and DSAR **4140.55**.

c. Discrepancy in Shipment Report (DISREP) (SF 361). Fill out **forward** Discrepancy in Shipment Report (DISREP) (SF 361) as prescribed in AR 55-38/NAVSUPINST 4610.33B/AFR 75-18/MCO P4610.19C and DLAR 4500.15.

1-4. Reporting Errors and Recommending

Improvements

You can help improve this manual. If you find any mistakes or if you know of a way to improve the procedures, please let us know. Mail your letter, DA Form 2028 (Recommended Changes to Publications and Blank Forms), or DA Form 2028-2 located in back of this manual direct to Commander, US Army Communications and Electronics Materiel Readiness Command, ATTN: DRSEL-ME-MQ, Fort Monmouth, NJ 07703. In either case, a reply will be furnished direct to you.

1-5. Military Nomenclature and Commercial

Designations

Throughout this manual, equipment **commercial designations** are used. Some of the equipments have been assigned Military nomenclature; these are listed in table 1-1.

Table 1-1. Official Military Nomenclature and Commercial Designations

Military nomenclature	Collins Radio Co. Type No.	Military nomenclature	Collins Radio Co. Type No.
Test Set, Antenna Coupler AN/ARM-109	Test Set 980H-1	Test Set, Discriminator TS-2352/AARM-109	Discriminator Tester 818L-17
Test Set, Antenna Coupler Control TS-2353/ARM-109	Antenna Coupler Control Tester 878L-15	Case, Test Set CY-6173/ARM-109	
Test Set, Electronic Control Amplifier TS-2354/ARM-109	Electronic Control Amplifier Tester 878L-16		

Section II. DESCRIPTION AND DATA

1-6. Description

(fig. 1-1)

a. **878L-15 Coupler Control Tester.**

The 878L-15 contains a power supply and switching matrix necessary to energize control circuits in the antenna coupler control module (Collins part number 528-0465-00). The 878L-16 employs lamp comparison and voltage test points for a go-no-go test of the coupler control module. A 3-foot extension cable is included to allow easier troubleshooting since the module has limited accessibility when mounted on the test set.

b. **878L-16 Electronic Control Amplifier Tester.**

The 878L-16 provides the inputs necessary to operate the electronic control amplifier module (Collins part number 528-0467-00). The 878L-16 employs lamp comparison and torque meter indications for a go-no-go test of the electronic control amplifier module. Because the module has limited accessibility when mounted on the test set, a 3-foot extension cable is included to permit easier troubleshooting.

c. **878L-17 Discriminator Tester.**

The 878L-17 simulates the actual operating condition under which the discriminator module (Collins part number 528-0468-00) operates in the antenna coupler. A 50-ohm, 150-watt resistive load simulates a properly matched antenna coupler and antenna. Reactance switched in parallel with the resistive load simulates an unmatched antenna coupler and antenna. The discriminator error signals are monitored by a meter on the front panel of the 878L-17. A 6-foot coaxial cable is included to connect the tester RF input to the transmitter.

d. **980H-1 Test Set.**

The 980H-1 consists of a watertight, molded plastic carrying case containing the 878L-15 Antenna Coupler Control Tester, the 878L-16 Electronics Control Amplifier Tester, the 878L-17 Discriminator Tester, power panel, and associated cables.

Note

Any reference in this manual to the 878L-15, 878L-16, or 878L-17 applies to the **980H-1**.

Table 1-2. Items Comprising AN/ARM-109

NSN	Qty	Nomenclature, part No., and mfr code	Fig. no.
6625-00-627-8692		Test Set, Antenna Coupler AN/ARM-109 consisting of NOTE The part number is followed by the applicable 5-digit Federal supply code for Manufacturers (FSCM) identified in SB 708-12 and used to identify manufacturer, distributor, or Government agency, etc.	
	1	Cable Assembly W-1: 761-4600-001; 13499	I-1
	1	Cable Assembly W-2: 761-4400-001; 13499	I-1
	1	Cable Assembly W-3: 554-6957-001; 13499	I-1
	1	Cable Assembly W-4: 554-6958-001; 13499	I-1
	1	Extender printed wiring board A1: 637-1902-001; 13499	I-1
	1	Extender printed wiring board A3: 637-1904-001; 13499	I-1

Table 1-3. Equipment Required But Not Supplied

Item	Quantity	Suggested Type
Transmitter	1	Receiver-Transmitter RT-698/ARC-102 (Collins, 618T)
Transmitter control	1	Control, Radio Set C-3940/ARC-94 (Collins, 714E-3)
Power source	1	115-vac, 400-Hz, single-phase
Coupler control module	1	Collins part number 528-0465-00

1-7. Tabulated Data

a. 878L-15 Coupler Control Tester.

Temperature range Operating 0°C (32°F) to 40°C (104°F). Nonoperating -62°C (-79.6°F) to 85°C (185°F).
 Humidity 5 days, 95 percent, 40°C.
 Altitude Operating 0 to 6,000 ft. Nonoperating 0 to 50,000 ft.
 Shock conditions 15 g, 11 ms, 3 each plane (18 shocks).
 Duty cycle Continuous.
 Warmup time None.
 Power requirements 105-125 vac, 380 to 420HZ, single-phase, 100-watt maximum.

b. 878L-16 Electronic Control Amplifier Tester.

Temperature range Operating 0°C (32°F) to 40°C (104°F). Nonoperating -62°C (-79.6°F) to 85°C (185°F).
 Humidity 5 days, 95 percent, 40°C.
 Altitude Operating 0 to 6,000 ft. Nonoperating 0 to 50,000 ft.

Shock conditions 15 g, 11 ms, 3 each plane (18 shocks).
 Duty cycle Continuous.
 Warmup time 5 minutes.
 Power requirements 105 to 125 vac, 395 to 405 Hz, single-phase, regulated, 25 watt variable.

c. 878L-17 Discriminator Tester.

Temperature range Operating 0°C (32°F) to 40°C (104°F). Nonoperating -62°C (-79.6°F) to 85°C (185°F).
 Humidity 5 days, 95 percent, 40°C.
 Altitude Operating 0 to 6,000 ft. Nonoperating 0 to 50,000 ft.
 Shock conditions 15 g, 11 ms, 3 each plane (18 shocks).
 Duty cycle 5 minutes on, 5 minutes off.
 Warmup time None.
 Power requirements 100-watt RF power.

d. 980H-1 Test Set.

Temperature range Operating 0°C (32°F) to 40°C (104°F). Nonoperating -62°C (-79.6°F) to 85°C (185°F).
 Humidity 48 hours, 95 percent, 50°C.
 Altitude Operating 0 to 6,000 ft. Nonoperating 6,000 to 50,000 ft.
 Shock conditions Per MIL-STD-810, method 516, procedure II with peak value of 20 g.
 Duty cycle Continuous.
 Warmup time 5 minutes.
 Power requirements 105 to 125 vac, 395 to 405 Hz, single-phase 100 watt variable, 100-watt RF power.

CHAPTER 2

SERVICE UPON RECEIPT OF EQUIPMENT AND INSTALLATION

2-1. Unpacking and Inspecting

This section contains the information required to unpack, test, and install the testers. Refer to figures 2-1,2-2,2-3, and 2-4 for installation control drawings. Carefully remove the units from their wrappings. Save all packing until inspection of the equipment has been completed. Check for visual defects. The packing material should be discarded only after the equipment has been found satisfactory. In case of damage, a claim must be filed with the shipping company. Such claims ordinarily required the inclusion of packing materials.

2-2. Preinstallation Test

a. 878L-15 Coupler Control Tester.

(1) Apply power (115-vac, 400-Hz single-phase) to the 878L-15.

(2) Set the POWER Switch to ON.

(3) To test the lamps, set the FUNCTION selector to position 17 and close the KEY switch. All the indicator lamps should be lighted.

CAUTION

This test must not be made with a control module connected to the tester.

(4) Set the FUNCTION selector to OFF.

(5) Connect a control module to the 878L-15.

(6) Rotate the FUNCTION selector control through the 12 test positions and observe the lighting sequence of the program (amber) lamps. (Refer to table 2-1 for the proper lighting sequence.)

Table 2-1. Lighting Sequence of Program Indicators for 878L-15

P1 Lamps	FUNCTION Selector Position											
	1	2	(key) 3	(key) 4	5	6	7	8	9	10	11	(key) 12
2			X									
4												X
6	X	X		X	X	X	X	X	X			X
9								X		X		
10												
11	X	X		X	X	X	X	X	X	X	X	X
12							X					
15	X	X		X	X	X	X	X	X	X	X	X
18								X				
19				X	X	X	X	X	X	X		
21						X	X	X				
22	X ⁴	X	X	X	X	X	X	X	X	X	X	X
24											X	
25					X	X	X	X	X	X		
31			X									
32			X									
33					X	X	X	X	X	X	X	X
34			X									
37				X	X	X	X	X	X	X	X	X
45					X	X	X	X	X	X		
49										X		
50	X	X	X	X	X					X		X
P2 Lamps	FUNCTION Selector Position											
3	X	X	X	X			X	X	X	X	X	
7	X	X	X	X	X		X	X	X	X		
12	X	X	X	X	X	X	X	X	X	X	X	X
13	X	X	X	X			X	X	X	X	X	X
14	X	X	X	X	X	X	X	X	X	X	X	X

Table 2-1. Lighting Sequence Program Indicators for 878L-15-Continued

P2 Lamps	FUNCTION Selector Position											
	1	2	(key) 3	(key) 4	5	6	7	8	9	10	11	(key) 12
16			X						X		X	
17			X		X	X	X	X	X	X	X	
19	X	X	X	X	X	X	X	X	X	X	X	X
21			X									
22			X									
23	X	X		X	X	X	X	X	X	X	X	X
25		X	X						X			
26			X							X		
27			X		X	X	X	X	X	X		
28	X	X	X	X	X	X	X	X	X	X	X	X
34										X	X	X
35										X	X	X

NOTES

1. X indicates lighted lamps.
2. All lamps are lighted when the FUNCTION selector is in position 17 and the KEY button is pressed. (A module must not be connected to the 878L-15.)
3. The KEY button must be pressed for correct indications when the FUNCTION selector is in positions 3, 4, and 12.
4. Lamp P1-22 will not light for modules above MCN 572.

Table 2-2. Lighting Sequence of Program Indicators for 878L-16

Switch Position	Program Indicators Lighted
1	24
2	24
3	8 and 16
4	8 and 28
5	8 and 16
6	Pilot only
7	24
8	24 and 27
9	23 and 27
10	23
11	Pilot only
OFF	Pilot only

b. 878L-16 Electronic Control Amplifier Tester.

NOTE

Do not conduct the following test with an electronic control amplifier module connected to the 878L-16.

- (1) Apply power to the 878L-16.
- (2) Set POWER switch (S2) to TEST. All indicators should be lighted and the TORQUE METER should indicate approximately 0.4 inch ounce.

(3) Set POWER switch (S2) to ON. Rotate FUNCTION selector (S1) through the 12 test positions and observe the lighting sequence of the program (amber) indicators. (Refer to table 2-2 for proper lighting sequence.)

c. 878L-17 Discriminator Tester.

- (1) Insure that P1 is connected to R5 (50-ohm, 150-watt Bird Load).
- (2) Connect transmitter output to J1 of the 878L-17.
- (3) Connect coaxial jumper from J2 to J3 of the 878L-17.
- (4) Set 878L-17 function selector to INPUT POWER.
- (5) Set the transmitter for a 100-watt output.
- (6) Set the transmitter frequency to 2.000 MHz.
- (7) Key the transmitter and observe that the 878L-17 meter pointer deflects.

NOTE

For input power calibration, refer to paragraph 6-4c.

2-3. Initial Adjustments

For initial adjustments, refer to calibration procedures (paragraph 6-4).

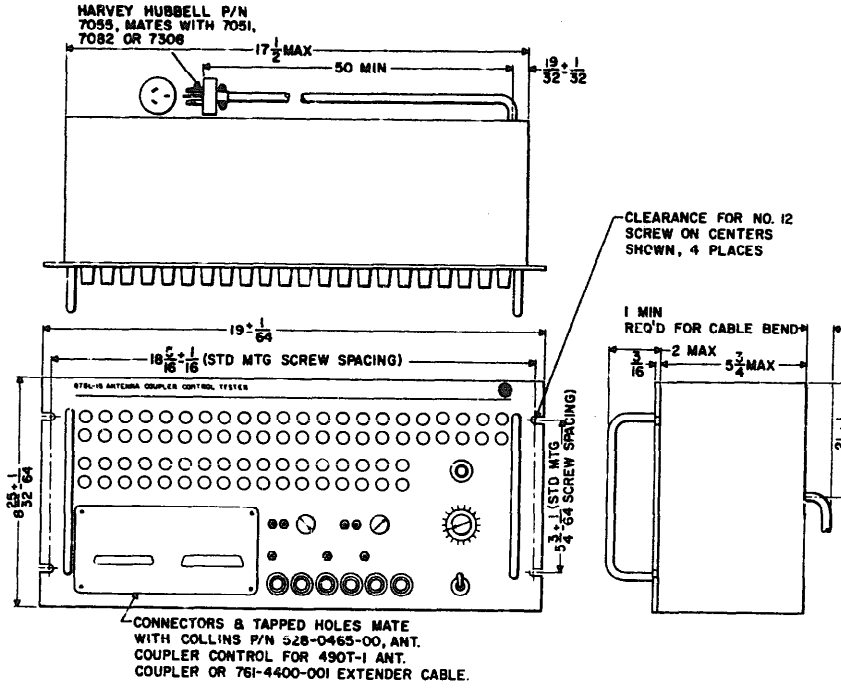

ELOCU008

Figure 2-1. TS-2353/ARM-109 Test Set Antenna Coupler Control outline and mounting dimension.

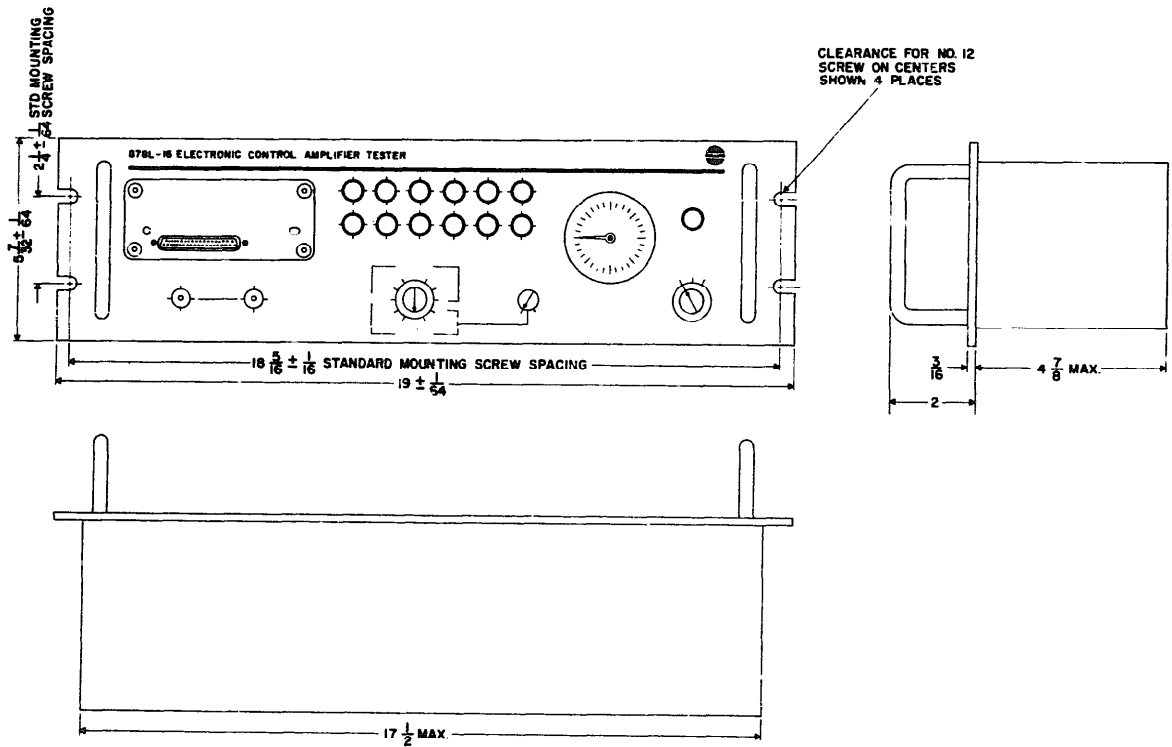

ELOCU009

Figure 2-2. TS-2354/ARM-109 Test Set, Electronic Control Amplifier

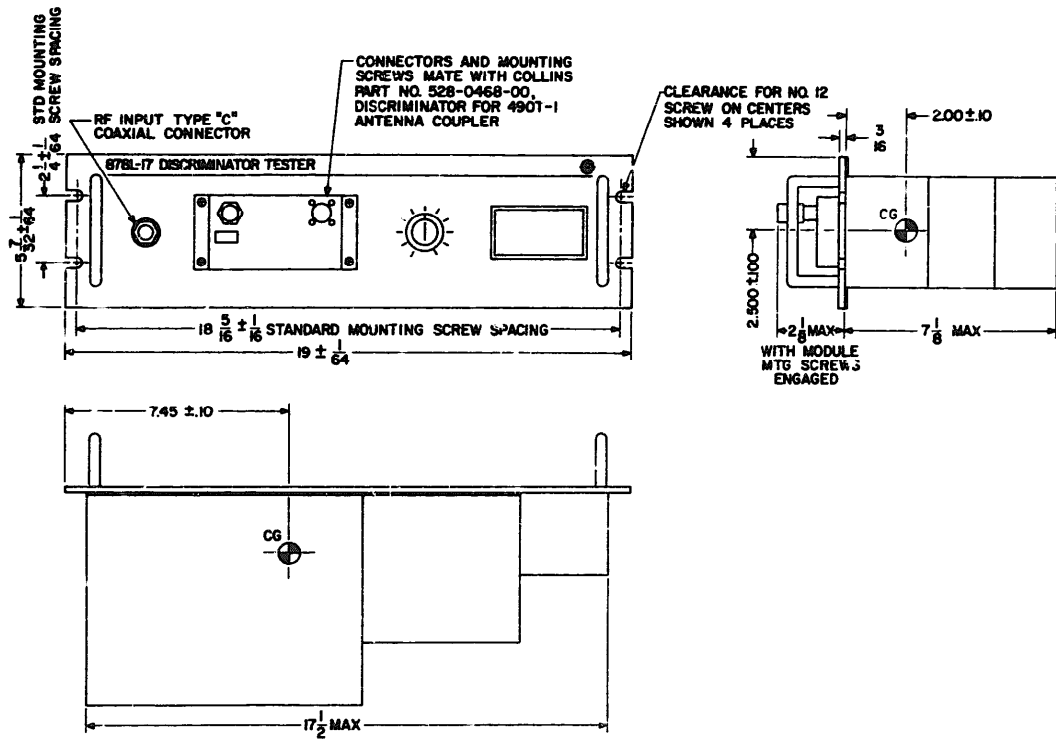

EL00010

Figure 2-3. 878L-17 Discriminator Tester, outline and mounting dimensions

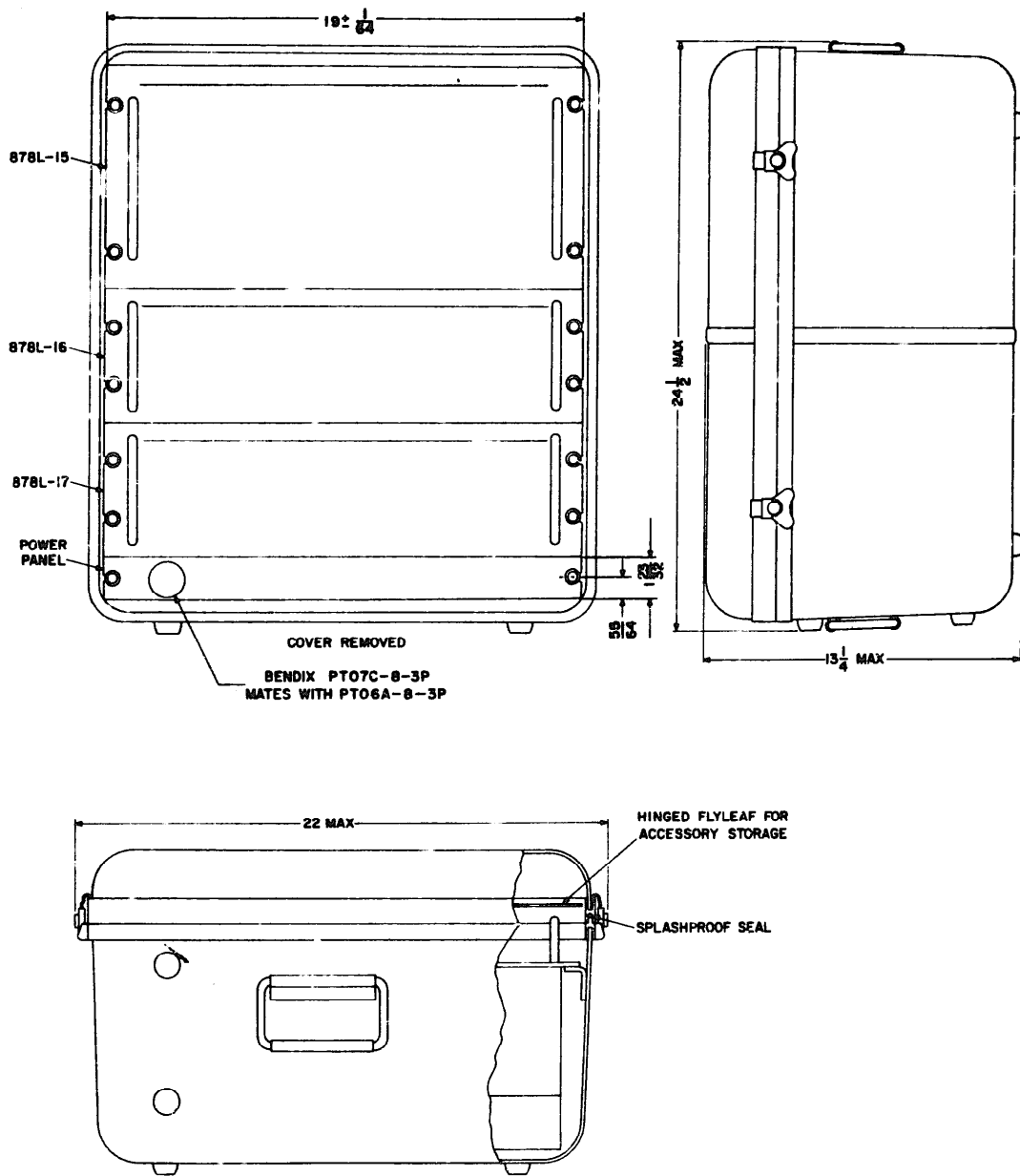

ELOCU011

Figure 2-4. 980H-1, Test set, outline and mounting dimensions.

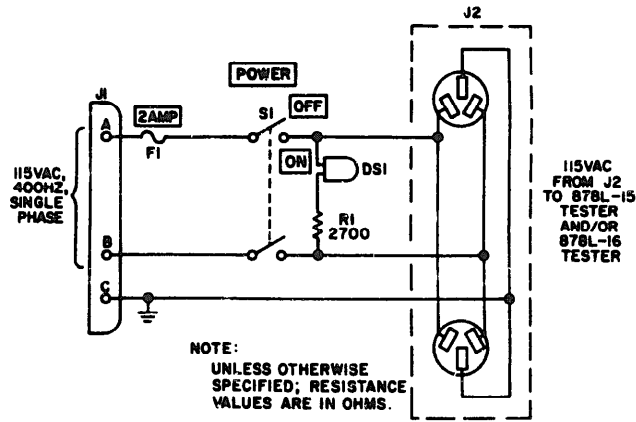

ELOCU016

Figure 2-5. Test Set 980H-1 Power Panel, Schematic Diagram.

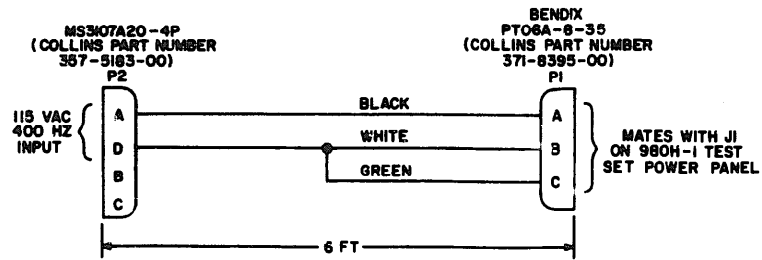

ELOCU017

Figure 2-6. Power Panel Special Cable Assembly W1, Schematic Diagram.

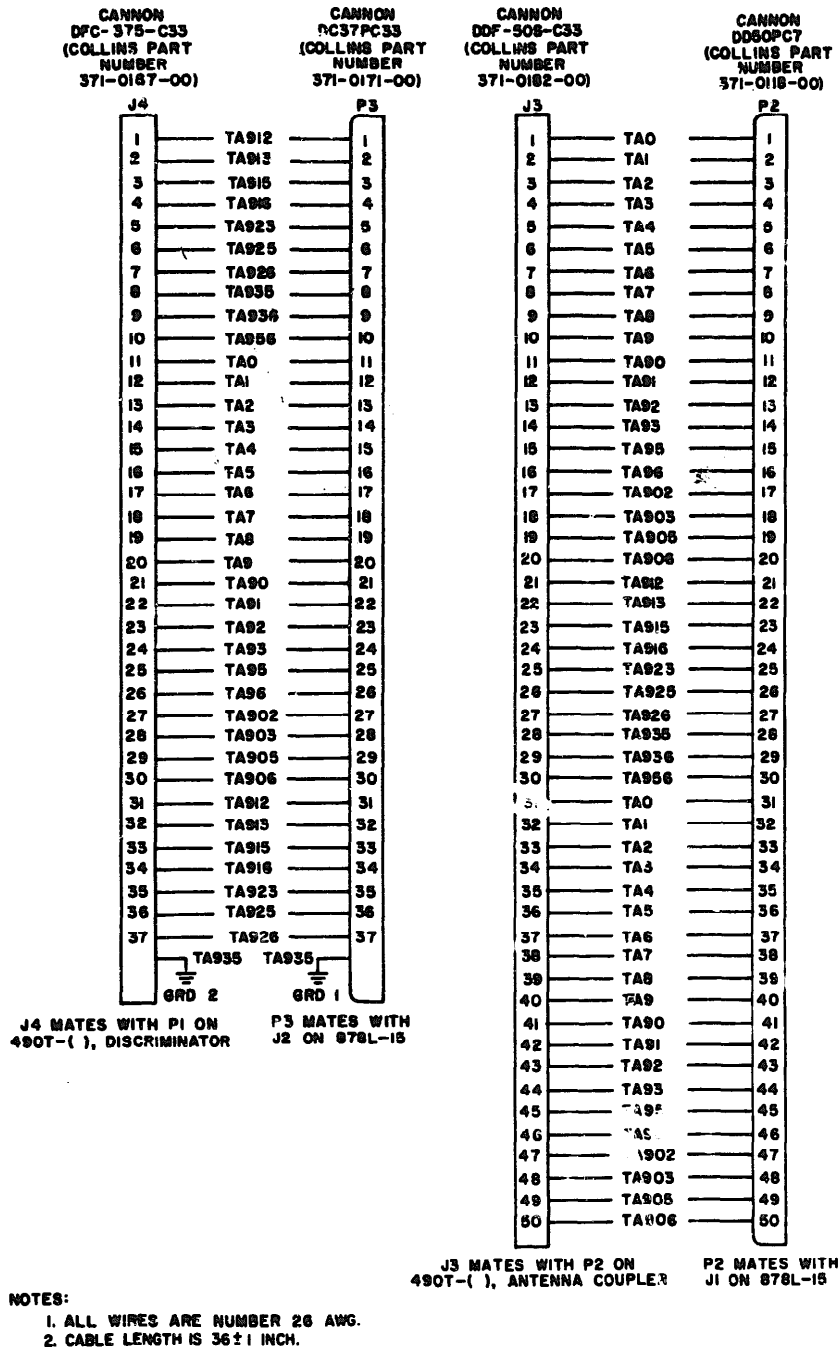

ELOC0018

Figure 2-7. 878L-15 Special Cable Assembly W2, Schematic Diagram.

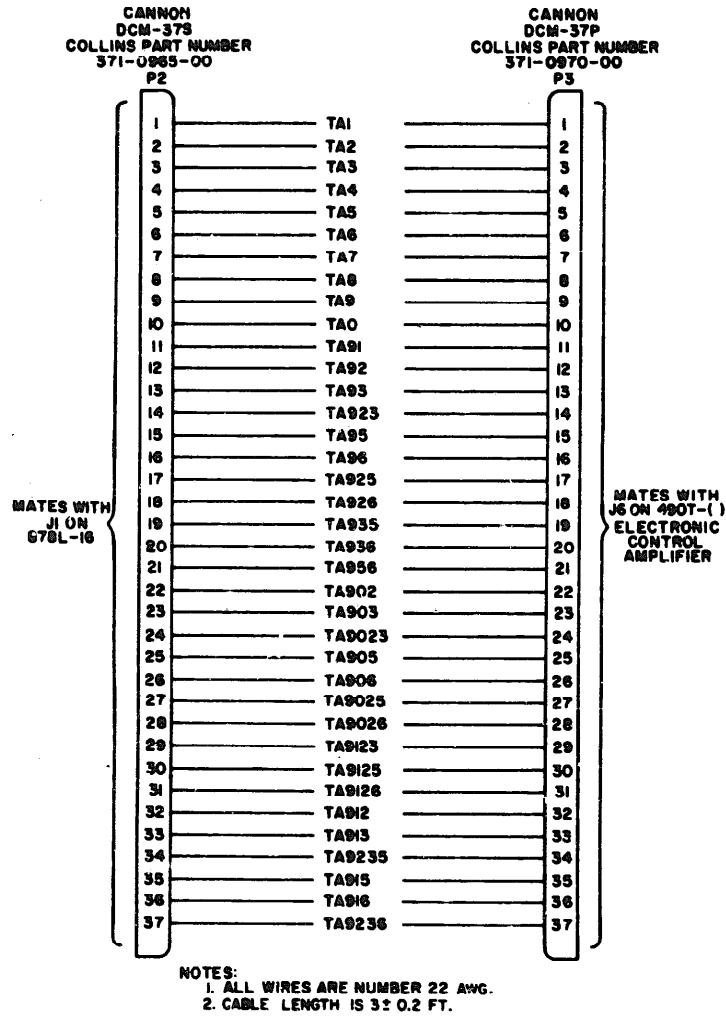

ELOCU019

Figure 2-8. 878-16 Special Cable Assembly W3, Schematic Diagram

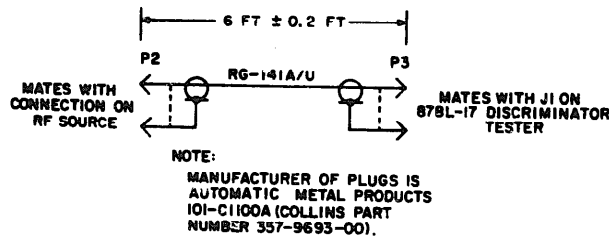

ELOCU020

Figure 2-9. 878L-17 Special Cable Assembly W4, Schematic Diagram.

CHAPTER 3
OPERATING INSTRUCTIONS

3-1. General

This section describes the function of the controls and indicators of the 878L-15/16/17 module testers. Test set operating procedures are also contained within this section.

3-2. Operating Controls

a. 878L-15 Antenna Coupler Control Tester Operating Controls.

Table 3-1 contains a description of the 878L-15 operating controls.

b. 878L-16 Electronic Control Amplifier Tester Operating Controls.

Table 3-2 contains a description of the 878L-16 operating controls.

c. 878L-17 Discriminator Tester Operating Controls.

Table 3-3 contains a description of the 878L-17 operating controls.

d. 980H-1 Power Panel Operating Controls.

Table 3-4 contains a description of the 980H-1 operating controls.

3-3. Operating Procedures

Subparagraphs *a*, *b*, and *c* contain operating procedures for the testers.

a. 980H-1 Test Set Operating Procedures.

(1) Connect power cable to a 115-vac, 400-Hz, single-phase power source.

(2) Set POWER switch S1 to ON position.

(3) Proceed to paragraph 3-3b, *c*, or *d* for applicable tester operation.

NOTE

Individual tester power cables are connected to the power source through the 980H-1 power panel; therefore, omit (1) in 878L-15 operating procedures (para 3-3b) and (2) in 878L-16 operating procedures (para 3-3c).

b. 878L-15 Antenna Coupler Control Tester Operating Procedures.

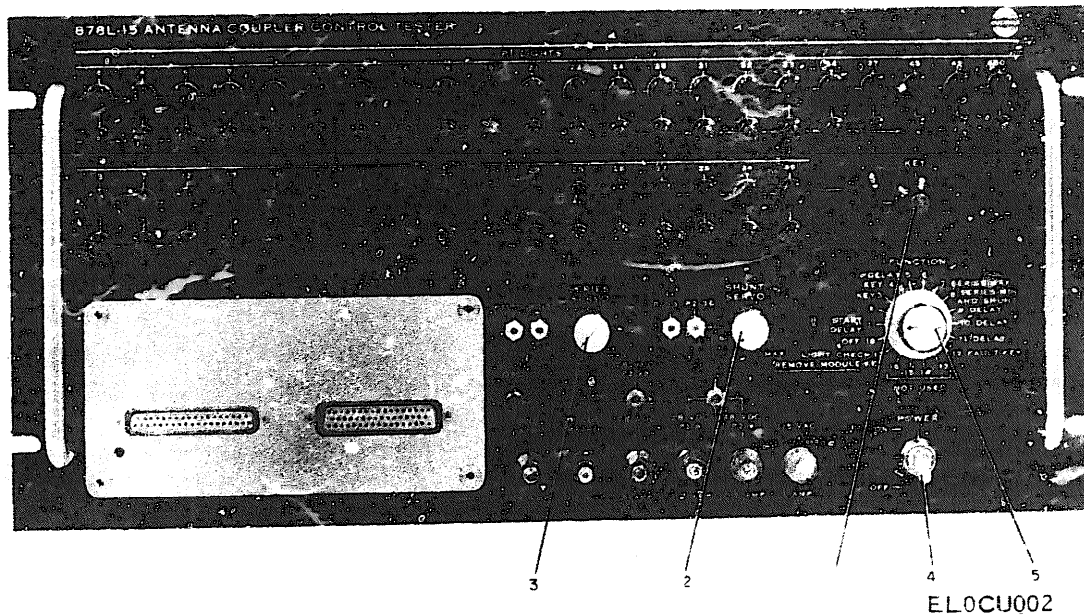

Figure 3-1. TS-2353/ARM-109, operating controls identification.

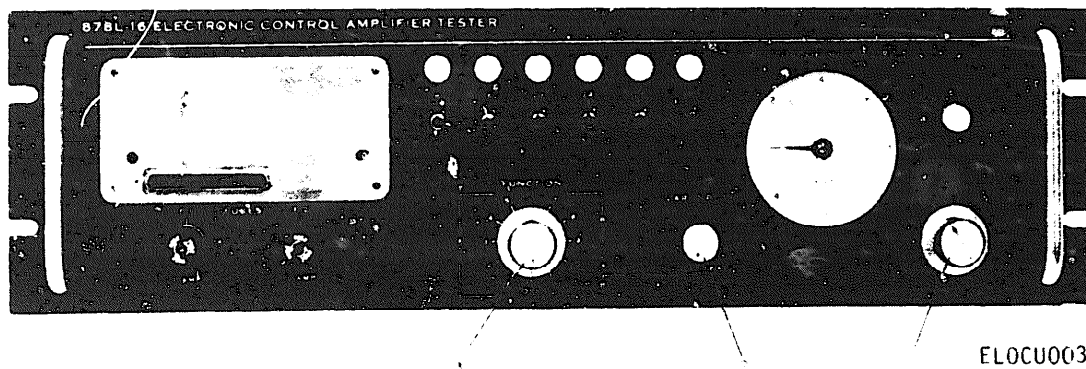

Figure 3-2. TS-2352/ARM-109 Operating controls identification.

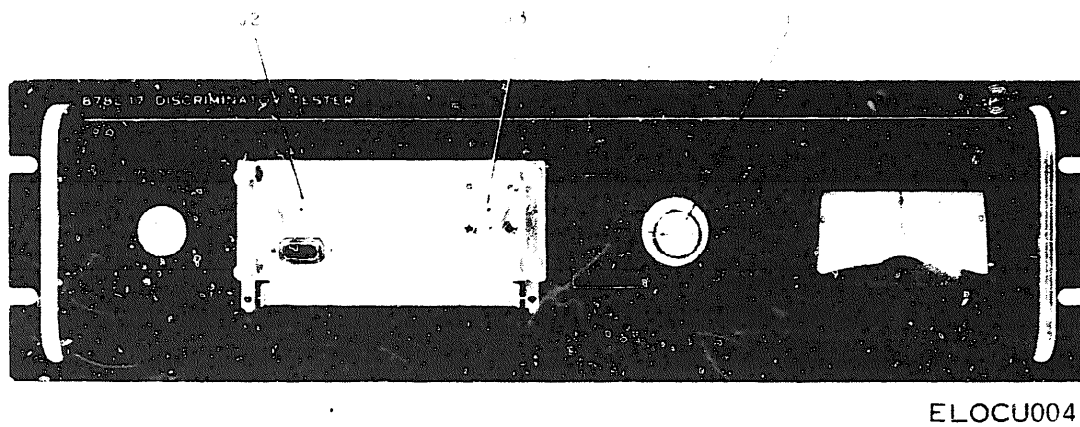

Figure 3-3. TS-2352/ARM-109 Operating control Identification.

(1) Connect the 878L-15 to a 115-vac, **400-Hz** single-phase power source.

(2) Connect a coupler control module to front panel of the 878L-15. To facilitate testing or troubleshooting, the module may be connected to the 878L-15 by the pendant cable. Extender cards may be used to extend tune sequence cards A1 and A3 for easier accessibility.

NOTE

Module must be firmly fastened to the 878L-16 or pendant cable to insure proper grounding of module.

(3) Set POWER switch to ON.

(4) Complete troubleshooting procedures outlined in applicable antenna coupler manual.

c. 878L-16 Electronic Control Amplifier Tester Operating Procedures.

(1) Set FUNCTION selector (S1) and POWER switch (S2) to OFF.

(2) Connect 878L-16 to a 115-vac, 400-Hz single-phase power source.

(3) Connect an electronic control amplifier module to the 878L-16. The module may be connected to the 878L-16 with the S-foot pendant cable to facilitate testing or troubleshooting.

N O T E

The module must be securely mounted to the 878L-16 or pendant cable to insure proper grounding of the module.

(4) Set the POWER switch (S2) to SELF TEST. TORQUE METER should indicate approximately 0.4 inch-ounce and all lamps should be lighted. If proper indications are not obtained refer to maintenance section of this manual.

(5) Set POWER switch (S2) to ON.

(6) Complete troubleshooting procedures outlined in applicable antenna coupler manual.

d. 878L-17 Discriminator Tester Operating Procedures.

CAUTION

Observe the duty cycle for the 878L-17 (5 minutes on, and 5 minutes off).

(1) Connect transmitter output of J1 of the 878L-17.

(2) Plug a loading-phasing discriminator module (Collins part number 528-0468-60) into J2, J3, and J4 of the 878L-17.

(3) Set transmitter for a 100-watt output.

(4) Complete troubleshooting procedures outlined in applicable antenna coupler manual.

Table 3-1. Description of 878L-15 Operating Controls

Item no. on fig. 3-1	Control name	Description	Function
1	KEY	Momentary pushbutton switch (S3)	<p>Grounds the digital tune in progress line in the module under test, when the FUNCTION selector is in position 3. Grounds the key line in the module under test, when the FUNCTION selector is in positions 4, 7, 8, and 12. Completes the energizing circuit for relay K1 when the FUNCTION selector is in position 17.</p> <p>NOTE</p> <p>The KEY switch <i>must be depressed in all the above mentioned positions every time the FUNCTION selector is in those positions or the testing sequence will be in error.</i></p>
2	SHUNT SERVO	Potentiometer (R2)	Varies the input to the loading on at ≈ 50 circuit in the module under test.
3	SERIES SERVO	Potentiometer (R1)	Varies the input to the series varicoil sense circuits in the module under test.
4	POWER	Spdt toggle switch	Completes the 115-vac circuit to 878L-15 test set.
5	FUNCTION	18-position wafer switch	Controls conduction of diode switching matrix within the 878L-15, thereby controlling application of test voltages to circuits in control module under test. (Refer to tables 6-3 and 6-4 for proper test voltages.)

Table 3-2. Description of 878L-16 Operating Controls

Item no. on fig. 3-2	Control name	Description	Function
1	Power switch	2-pole, 3-position, wafer switch	Completes the 115-vac input circuit to the power transformer.

Table 3-2. Description of 878L-16 Operating Controls-Continued.

Item no. on fig. 3-2	Control name	Description	Function
2	VAR INPUT	Potentiometer	<p><i>Switch Pos</i> <i>Function</i></p> <p>SELF TEST Applies power to the TORQUE METER and all the indicator lamps.</p> <p>GN Completes the circuit from the servoamplifier output to the TORQUE METER.</p> <p>Varies the negative error signal input to the servoamplifiers when the FUNCTION selector is in positions 10 and 11.</p> <p><i>Switch Pos</i> <i>Function</i></p> <p>0 Supplies no error signal to the servoamplifiers.</p> <p>SAT Applies maximum error signal input to the servoamplifiers.</p>
3	FUNCTION selector	12-position wafer switch	<p>Selects the proper circuit in the 878L-16 to perform the tests indicated below:</p> <p><i>Switch Pos</i> <i>Function</i></p> <p>1 Applies a negative error signal to amplifier A (series varicoil), completes the circuit to momentarily energize K1, applies power to program (amber lamp 24, and applies the output from the servoamplifier to the TORQUE METER in the proper phase with the reference voltage to allow the meter to operate clockwise.</p> <p>2 Completes the energizing circuit for the tune B relay, applies a positive error signal through the tune B relay to servoamplifier A, applies power to program lamps 9 and 24, and applies the output power from the servoamplifier to the TORQUE METER in the proper phase with the reference voltage to allow the meter to operate clockwise.</p> <p>3 Completes the energizing circuit for the tune B relay, applies a positive error signal through the tune B relay to servoamplifier A, applies power to program lamps 8 and 16, completes tune B damping relay circuits, applies power to momentarily energize relay K1, and applies the output power from the servoamplifier to the TORQUE METER in the proper phase with the reference voltage to allow the meter to operate clockwise.</p> <p>4 Completes the energizing circuit for the tune B relay, applies a positive error signal through the tune B relay to servoamplifier A, applies power to program lamps 8 and 28, completes servo gain relay circuits, completes a circuit to back bias tune B damping diode (CR13), and applies the output power from the servoamplifier to the TORQUE METER in the proper phase with the reference voltage to allow the meter to operate clockwise.</p> <p>the tune B relay, grounds the input to servoamplifier A, applies power</p>

Table 3-3. Description of 878L-16 Operating Controls-Continued

Item no. on fig. 8-3	Control name	Description	Function
			<i>Switch Pos</i> <i>Function</i>
			to program lamps 8 and 16, forward biases tune B damping diode (CR3), applies power to momentarily energize relay K1.
			6 Not used.
			7 Applies a negative error signal to servoamplifier B (shunt varicoil), grounds the gate circuit of RF relay switch (Q15), applies power to program lamp 24, applies power to momentarily energize relay K1, and applies the output power from the servoamplifier to the TORQUE METER in the proper phase with the reference voltage to allow the meter to operate clockwise.
			8 Completes the energizing circuit for the tune B relay, applies power to program lamps 24 and 27, completes the gate circuit of the rf relay switch (Q15).
			9 Completes the energizing circuit for the tune B relay, applies a positive error to servoamplifier B, applies power to program lights 23 and 27, applies power to momentarily energize relay K1, and applies the output power from the servoamplifier to the TORQUE METER in the proper phase with the reference voltage to allow the meter to operate clockwise.
			10 Applies a variable negative error signal to servoamplifier A, applies power to program light 23, and applies the output power from the servoamplifier to the TORQUE METER in the proper phase with the reference voltage to allow the meter to operate clockwise.
			11 Applies a variable, negative error signal to servoamplifier B and applies the output power from the servoamplifier to the TORQUE METER in the proper phase with the reference voltage to allow the meter to operate clockwise.

Table 3-3. Description of 887L-17 Operating Controls

Item No. on Fig. 8-3	Control name	Description	Function						
1	CIRCUIT SELECTOR	12-position wafer switch	<p>Selects required circuit within 878L-17 for test functions indicated below:</p> <table style="width: 100%; border: none;"> <tr> <td style="width: 50%; border: none;"><i>Switch pos</i></td> <td style="width: 50%; border: none;"><i>Function</i></td> </tr> <tr> <td style="border: none;">MHz through 30-MHz</td> <td style="border: none;">Switches reactive components in parallel with 50-ohm resistive load to simulate actual phasing discriminator unbalance. METER (M1) will indicate phasing error produced.</td> </tr> <tr> <td style="border: none;">PHASE</td> <td style="border: none;">Connects the 50-ohm resistive load in the RF circuit to allow adjustment of the phasing discriminator.</td> </tr> </table>	<i>Switch pos</i>	<i>Function</i>	MHz through 30-MHz	Switches reactive components in parallel with 50-ohm resistive load to simulate actual phasing discriminator unbalance. METER (M1) will indicate phasing error produced.	PHASE	Connects the 50-ohm resistive load in the RF circuit to allow adjustment of the phasing discriminator.
<i>Switch pos</i>	<i>Function</i>								
MHz through 30-MHz	Switches reactive components in parallel with 50-ohm resistive load to simulate actual phasing discriminator unbalance. METER (M1) will indicate phasing error produced.								
PHASE	Connects the 50-ohm resistive load in the RF circuit to allow adjustment of the phasing discriminator.								

Table 3-3. Description of 878L-17 Operating Controls-Continued

Item No. on Fig. 3-3	Control name	Description	Function
			<i>Switch Pos</i> <i>Function</i>
		INPUT POWER	Connects a power output detector in parallel with the 50-ohm resistive load. Permits monitoring of the source RF.
		LOAD	Connects discriminator module dc output signal, which is proportional to the resistive component of the RF line impedance, to METER (M1) for test and adjustment.
		FWD POWER	Connects discriminator module dc output signal, which is proportional to the power traveling toward the load, to the METER (M1) for test.
		REFL POWER	Connects discriminator module dc output signal, which is proportional to the reflected power from the antenna, to METER (M1) for test.
		REFL SENS	Connects unbalance resistor (R6) in parallel with the 50-ohm resistive load to permit monitoring of reflected power error.
		LOAD SENS	Connects unbalance load resistor (R6) in parallel with the 50-ohm resistive load to permit monitoring of loading error signal.

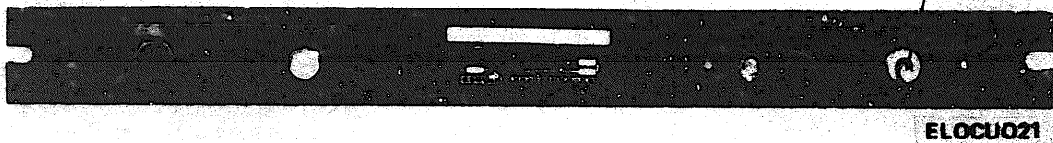

ELOCU021

Figure 3-4. AN/ARM-109 Power Panel, Operating Controls Identification.

Table 3-4. Description of Power Panel Operating Controls

Item no on fig 3-4	Control name	Description	Function
1	Power switch	Dpst toggle switch	Completes the 115-V ac, 400-Hz single-phase input circuit to the power panel for the 878L-15 and 878L-16 testers. Powers the on-off lamp.

C H A P T E R 4
ORGANIZATIONAL MAINTENANCE

Section I. GENERAL

4-1. Scope of Maintenance

The maintenance duties assigned to the organizational electronic equipment repairman are listed below together with a reference to the paragraphs covering the specific maintenance functions. The duties include instructions for performing preventive and corrective maintenance and do not require tools or test equipment other than those allocated.

- a. Cleaning (para 4-5).
- b. Organizational preventive maintenance checks and services (para 4-4).

- c. Removal and replacement of control unit panel lamps and knobs.

4-2. Tools, Test Equipment, and Materials

The tools, test equipment, and materials required are listed below.

- a. Tool Kit, Electronic Equipment TK-101/G.
- b. Multimeter AN/URM-105.
- c. Fine sandpaper, No. 0000.
- d. A soft-bristled brush.
- e. A clean lint-free cloth.
- f. Trichloroethane.

Section II. PREVENTATIVE MAINTENANCE PROCEDURES

4-3. Preventive Maintenance

Preventive maintenance is the systematic care, servicing, and inspection of equipment to prevent the occurrence of trouble, to reduce out-of-service time, and to maintain equipment serviceability.

a. Systematic Care. The procedures given in paragraphs 4-4 and 4-5 cover routine systematic care and cleaning essential to proper upkeep and operation of the equipment.

b. Preventive Maintenance Checks and Services. The preventive maintenance checks and services chart (para 4-4) outlines the functions to be performed at specific intervals. These checks and services are designed to maintain Army equipment in a combat-serviceable condition; that is, in good general (physical) condition and in good operating condition. To assist organizational maintenance repairmen in maintaining combat serviceability, the chart indicates what to check, how to check, the normal conditions; the time required to perform the checks and services is shown as man-hours in the work time column of the defect cannot be remedied by the organizational maintenance repairman, higher category of maintenance is required. Records and reports of these checks must be made in accordance with TM 38-750.

tion; that is, in good general (physical) condition and in good operating condition. To assist organizational maintenance repairmen in maintaining combat serviceability, the chart indicates what to check, how to check, the normal conditions; the time required to perform the checks and services is shown as man-hours in the work time column of the defect cannot be remedied by the organizational maintenance repairman, higher category of maintenance is required. Records and reports of these checks must be made in accordance with TM 38-750.

4-4. Organizational Preventive Maintenance Checks and Services

Q-Quarterly

Total man-hours required: 0.9

Sequence Number	ITEM TO BE INSPECTED PROCEDURE	Work-time (MH)
1	EXTERIOR SURFACES a. Clean front panels. b. Inspect exposed metal surfaces for rust, corrosion, and bare spots.	0.1
2	CABLES AND CONNECTORS Check interconnecting cables for cuts, kinks, and frayed insulation. Repair as necessary. Refer to high echelon for replacement.	0.1
3	MOUNTING a. Check equipment for proper installation. b. All nuts, bolts, and washers are present and properly tightened. c. Mounting shows no sign of weakness or deformity.	0.1
4	PRELIMINARY OPERATION a. Check Antenna Coupler Control Tester 878L-15 for proper functioning (para 2-2a). b. Check Electronic Control Amplifier Tester 878L-16 for proper functioning (para 2-2b). c. Check Discriminator Tester 878L-17 for proper functioning (para 2-2c).	0.2 0.2 0.2

4 - 5 . C l e a n i n g

All exterior surfaces of the equipment should be free of dirt, grease, and fungus. Perform the following procedures as specified in the preventive maintenance checks and services charts.

a. Remove moisture and loose dirt with a clean soft cloth.

W a r n i n g

The fumes of trichloroethane are toxic. Provide thorough ventilation whenever used. DO NOT use near an open flame. Trichloroethane is not flammable, but exposure of the fumes to an open flame converts the fumes to highly toxic dangerous gases.

b. Remove grease, fungus, and ground-in dirt from the exterior surfaces with a clean cloth dampened (not wet) with trichloroethane. Wipe dry with a clean, dry, lint-free cloth.

c. Clean the front panel and controls; use a clean soft cloth. If dirt is difficult to remove, dampen the cloth with water; if necessary, use mild soap.

d. Remove rust and corrosion from metal surfaces by lightly sanding them with fine sandpaper. Brush two thin coats of paint on the bare metal to protect it from further corrosion. Refer to the applicable cleaning and refinishing practices specified in TB 43-0118.

CHAPTER 5

FUNCTION OF EQUIPMENT

5-1. Electronic Functioning

This chapter contains the detailed electronic functioning of the 878L-15/16/17 module test set circuitry.

5-2. Antenna Coupler Control Tester Circuit Analysis

a. Transformer T1 provides the necessary operating voltages to the antenna coupler control module under test. The antenna coupler control module provides the filtered 28 volts dc necessary for the operation of indicator lamp circuits and testing circuits of the 878L-15. The diode switching matrix completes the circuit for the proper program (amber) lamps and energizes the proper antenna coupler control module circuits for each position of the FUNCTION selector.

b. When the FUNCTION selector is in position 3, the discharge of antenna coupler control capacitor C24 (series and shunt varicoil homing volts) gates silicon controlled rectifiers (scr's) CR3 and CR4 into conduction. The operation of an scr is similar to that of a thyratron. An scr conducts with proper anode voltage and proper gate current. The gate current may be removed and the scr continues to conduct until the anode voltage is decreased below the holding voltage of the scr. Silicon controlled rectifiers CR3 and CR4 are employed to insure the illumination of DS1-31 and DS2-22 until the FUNCTION selector is conditioned to a different test position.

c. The circuit composed of resistor R1, capacitor C1 and FUNCTION selector S2E front and rear provides the 400-Hz signal necessary to energize the series varicoil maximum sense and the series varicoil minimum sense circuits in the antenna coupler control. The 400-Kz input is phase-shifted slightly by the differential circuit R1 and C1. This phase shift compensates for the phase shift of the servoamplifier chopper during normal antenna coupler operation. The magnitude of the 400-Hz signal may be monitored by an ac vtvm connected to jacks P2-20 and P2-30. Adjustment of the SERIES SERVO control (R1) varies the 400-Hz output. The 400-Hz output phase is reversed by switches S2E, front and rear.

d. The circuit composed of resistor R2, capacitor C2, and switches S2D front and rear provides the 400-Hz signal necessary to energize the loading on the ≈ 50 circuit in the antenna coupler control. The **400-HZ input** is phase-shifted slightly by differential circuit R2 and C2. This phase shift compensates for the phase shift of the servoamplifier chopper during normal antenna coupler operation. The magnitude of the 400-Hz signal may be monitored by an ac vtvm connected to jacks P1-13 and P2-36. Adjustment of the SHUNT SERVO control (R2) varies the 400-Hz output. The **400-HZ** output phase is reversed by switches S2D, front and rear.

e. Relay K1 is energized when the FUNCTION selector is in position 17 and the KEY button is depressed. Relay K1 forward biases diodes in the matrix and on TB1 completing all lamp circuits. Voltage across terminals 4 and 6 of transformer T1 is rectified by diodes CR1 and CR2 to provide the +28 volts dc for the lamp circuits.

5-3. Electronic Control Amplifier Tester Circuit Analysis

a. The negative portion of the 400-Hz output from transformer T1 is rectified by CR3, filtered by C9, R2, C2, and R3, and regulated by CR7. This dc voltage simulates a negative error signal from the phasing and loading discriminator. The positive portion of the 400-Hz output from transformer T1 is rectified by CR4, filtered by C7A, R4, C7B, and R5, and regulated by CR8. This dc voltage simulates a positive error signal from the phasing and loading discriminator.

b. Full-wave rectifiers CR1 and CR2 provide a 28-volt dc supply used for the lamp circuits and to energize relays in the module under test.

c. The FUNCTION selector controls the operation of the amplifier and relay circuits in the module under test. It also controls the power to the 878L-16 (amber) lamps. The TORQUE METER monitors the operation of the servoamplifiers, and the indicator lamps monitor the operation of the rf relay switch, the gain relay, and the tune B damping relay in the electronic control amplifier.

d. Relay K1 provides the ground necessary for conduction of electronic control amplifier band information scr's Q14 and Q15.

e. The operating controls in table 3-2 describe the inputs and electronic control amplifier circuits under test for each position of the 878L-16 FUNCTION selector.

5-4. 878L-17 Discriminator Tester Circuit

A n a l y s i s

a. The **PHASE SENS (2 MHz through 30MHz)** positions of the CIRCUIT SELECTOR place reactive elements in parallel with the 50-ohm resistive load to simulate an antenna of improper length with a 50-ohm resistive component. The discriminator module under test develops a dc error signal proportional to the RF line voltage and RF line current phase shift created by the parallel reactive and resistive circuit. **METER M1** provides an indication proportional to the magnitude of the dc error signal. Measurement of the phasing error signal provides an accurate test of the operation of the phasing discriminator.

b. The **PHASE** position of the CIRCUIT SELECTOR places the 50-ohm resistive load into the RF circuit. Resistor R9 in the discriminator under test may then be adjusted for a zero error signal output.

c. When the CIRCUIT SELECTOR is in the **INPUT POWER** position a power detector is placed in parallel with the 50-ohm load. This action permits monitoring of the RF power output of the transmitter.

d. When the CIRCUIT SELECTOR is in the **LOAD** position, the 50-ohm resistive load is switched into the rf circuit and the loading error signal from the discriminator under test is switched into the meter signal. The loading discriminator develops a dc error signal proportional to the difference between the line resistance and 50 ohms. Capacitor C4 in the discriminator under test should be adjusted for a zero error signal output.

e. When the CIRCUIT SELECTOR is in the **FWD POWER** position, the 50-ohm resistive load is switched into the RF circuit and the for-

ward power error signal from the discriminator under test is switched into the METER circuit. The forward power discriminator develops a dc error signal proportional to the forward power of the transmitted signal. The magnitude of this error signal is indicated on the 878L-17 METER.

f. When the CIRCUIT SELECTOR is in the **REFL POWER** position, the 50-ohm resistive load is switched into the RF circuit and the reflected power error signal from the discriminator under test is switched into the meter circuit. The magnitude of this error signal is indicated on the 878L-17 METER.

g. When the CIRCUIT SELECTOR is in the **REFL SENS** position, a 500-ohm resistance is switched in parallel with the 50-ohm load and the resistance combination switched into the RF circuit. The reflected power error signal from the discriminator under test is switched into the meter circuit. Due to the parallel resistance configuration the transmitter load resistance is less than 50 ohms; therefore, the magnitude of the reflected power error signal is increased. The algebraic difference between the error signal developed when the load is 50 ohms and the error signal developed with the load deviates from 50 ohms in the power sensitivity. Due to the analog readout of the 878L-17 the reflected power sensitivity need not be calculated.

h. When the CIRCUIT SELECTOR is in the **LOAD SENS** position, a 500-ohm resistance is switched in parallel with the 50-ohm load and the resistance combination switched into the RF circuit. The loading error signal from the discriminator under test is switched into the meter circuit. Due to the parallel resistance configuration the transmitter load resistance is less than 50 ohms; therefore, the magnitude of the loading error signal is increased. The algebraic difference between the error signal developed when the load is 50 ohms and the error signal developed with the load deviates from 50 ohms in the load sensitivity. Due to the analog readout of the 878L-17, the load sensitivity need not be calculated.

CHAPTER 6

GENERAL SUPPORT MAINTENANCE

6-1. Troubleshooting Data

This chapter contains the information required for the general support maintenance of the 878L-15/16/17 module tester. This chapter contains minimum performance procedures, troubleshooting procedures, typical voltage charts and preventive maintenance routines. Refer to table 6-1 for test equipment required to maintain 878L-15/16/17 module tester.

WARNING

Be extremely careful when troubleshooting the internal circuits of the receiver-transmitter unit; dangerous voltages exist in the unit. Always disconnect the equipment from the power source when making internal repairs or resistance measurements.

a. Organization of Troubleshooting Procedures. The first step in troubleshooting a defective radio set is to sectionalize the fault. Sectionalization means tracing the fault to a major component. The second step is to localize the fault. Localization means tracing the fault to a circuit or module. The third step is to isolate the fault. Isolation means tracing the fault to a defective part responsible for the abnormal condition. Some faults such as burned-out resistors, arcing or shorted transformers can often be located by sight, smell, and hearing. The majority of faults, however, must be isolated by checking voltages and resistances.

b. Sectionalization. Listed below is a group of tests arranged to reduce unnecessary work and to aid in tracing trouble in a defective test set. Test Set, Antenna Coupler AN/ARM-109 consists of three units: the antenna coupler control, electronic control amplifier, and discriminator tester. The first step is to locate the unit or units at fault by the following methods:

(1) **Visual inspection.** The purpose of visual inspection is to locate faults without testing or measuring circuits. The monitor meter on the front of the receiver-transmitter and other visual signs should be observed and an attempt made to sectionalize the fault to a particular unit.

(2) **Operational tests.** Operational tests frequently indicate the general location of trouble. In many instances, the tests will help in determining the exact nature of the fault. The periodic preventive maintenance checks and services is a good operational test.

c. Localization. After the trouble has been sectionalized (**b** above), the methods listed below will aid in localizing the trouble to a circuit or module in the suspected unit.

(1) **Troubleshooting charts.** The trouble symptoms in the troubleshooting charts (table 6-5) provide additional information for localizing troubles.

d. Isolation. After the trouble has been localized (**c** above), the methods listed in (1) through (5) below aid in isolating the trouble to a defective circuit element.

(1) **Waveform analysis.** For some circuits in this equipment, waveforms must be taken and compared with the waveforms given. Resistance measurements ((3) below) must then be taken to isolate the trouble.

(2) **Voltage measurements.** Portions of this equipment are transistorized. When measuring voltages, use tape or sleeving (spaghetti) to insulate the entire test prod, except for the extreme tip. A momentary short circuit can ruin a transistor. Use the same or equivalent item of test equipment specified in the procedures.

(3) **Resistance measurements.** Make resistance measurements in this equipment only as directed. Use the test equipment range specified in the procedures, otherwise the indications obtained may be inaccurate.

CAUTION

Before using any item of test equipment to test transistors or transistor circuits, **check the open-circuit voltage across the test equipment leads.** Do not use the test equipment if the open-circuit **voltage exceeds 1.5 volts.** Also, since the **RX1** range normally connects the test equipment internal battery directly across the test leads, the comparatively high current (50 MA or more) may damage the transistor

under test. As a general rule, it is not recommended that the RX1 range of **any** test equipment be used when testing low-power circuits.

(4) **Test points.** Some of the modules of this equipment are equipped with test points to facilitate connection of test equipment. These test points should be used whenever specified to avoid needless disassembly of the equipment.

(5) **Intermittent troubles.** In all of the tests, the possibility of intermittent troubles should not be overlooked. If present, this type of trouble often may be made to appear by tapping or jarring the equipment. Make a visual inspection of the wiring and connections to the units of the equipment. Minute cracks in printed circuit boards can cause intermittent operation. A magnifying glass is often helpful in locating defects in printed circuit boards. Continuity measurements of printed conductors may be made using the same technique ordinarily used on hidden conventional wiring; observe test equipment precautions discussed in (3) above.

6-2. 878L-15 Antenna Coupler Control Tester

a. **Minimum Performance.** The **minimum per-**

formance test for the 878L-15, described in table 6-2 consists of a series of tests performed on the test bench. Successful completion of the tests will insure that the unit is functioning within acceptable limits of performance.

b. **Troubleshooting Chart.** A troubleshooting chart for the 878L-15, is provided in table 6-5. Fault indication is based on trouble encountered during minimum performance tests. The test steps of the troubleshooting chart are arranged in the same sequence as the test steps in the minimum performance test. If a fault occurs during minimum performance test, refer to the corresponding step in the troubleshooting chart to determine probable cause and remedy.

Table 6-1. Test Equipment Required

Common name	Nomenclature
AC vtvm (Hewlett-Packard 410B)	Voltmeter, Meter ME--26B/U
DC vtvm (Fluke 801B, 0.3 volt within 0.5%)	Voltmeter, Electronic AN/USM-98
Vom (Triplett 630)	Multimeter TS-352B/U
Impedance bridge (Boonton 250A)	Test Set, Capacitance-Inductance Resistance AN/URM-90
Ohmmeter Hewlett-Packard 410B)	Voltmeter. Meter ME-26B/U

Table 6-2. 878L-15 Antenna Coupler Control Tester Minimum Performance Test

Step No.	Description of test	Test equipment	Control Settings and instructions	Required Indication
1	Lamp test.	None.	POWER switch in ON position and FUNCTION selector in position 17. Press KEY button. NOTE This test must not be performed with a coupler control module connected to the 878L-15. NOTE The KEY push-button must be depressed in positions 3, 4, 7, 8, and 12 every time the FUNCTION selector is in these positions (even when just going past them) for the test to work.	All indicator lamps must be lighted.
2	Program (amber) lamp test.	None.	POWER switch in ON position and FUNCTION selector rated through the 12 test positions.	Refer to table 2-1. NOTE There will be no indication if the coupler control module

Table 6-2. 878L-15 Antenna Coupler Control Tester Minimum Performance Test-Continued

Step No.	Description of test	Test equipment	Control Settings and instructions	Required indication
			This test must be performed with a coupler control module connected to the 878L-15.	NOTE does not supply 28 vdc to the 878L-15.
3	Ground matrix diode.	Ohmmeter. (connect negative lead to GRD jack and positive lead to test points as indicated in table 6-3.) NOTE When using ME-26 D/U only, connect positive lead to ground and negative lead to test points.	POWER switch in OFF position rotate FUNCTION selector through 12 test positions. Remove coupler control module for this test.	Refer to table 6-3.
4	28 vdc matrix diode.	Ohmmeter. (connect positive lead to GRD jack and negative lead to test points as indicated in table 6-4.)	POWER switch in OFF position rotate FUNCTION selector through 12 test positions. The coupler control module must not be connected for this test.	Refer to table 6-4.
5	DTIP circuit.	Ohmmeter. (Connect negative lead to GRD jack and positive lead to J1-28.)	POWER switch in OFF position and FUNCTION selector in position 3. Press Key button. The coupler control module must not be used for this test.	Ohmmeter indicates continuity.
6	Key circuit.	Ohmmeter. (Connect negative lead to GRD jack and positive lead to J1-20.)	POWER switch in OFF position and FUNCTION selector in position 4, 7, 8, and 12. Press the KEY button for each FUNCTION selector setting.	Continuity at each FUNCTION selector setting.
7	Reflected power output.	DC vtvm.	POWER switch in ON position and rotate FUNCTION selector through 12 test positions. NOTE A coupler control module must be connected to the 878L-15 for this test. (See note step no. 1).	3.5 to 5 vdc from TB1-143 to ground in positions 10 and 12.
8	Minimum step coil stop.	Ohmmeter. (Connect negative lead to GRD jack and positive lead to J2-31.)	POWER switch in OFF position and rotate FUNCTION selector through 12 test positions. NOTE A coupler control module must not be used for this test.	Continuity in position 6 only.

Table 6-2. 878L-15 Antenna Coupler Control Tester Minimum Performance Test—Continued

Step No.	Description of test	Test equipment	Control Settings and instructions	Required indication
9	Minimum step coil stop.	Ohmmeter. (Connect negative lead to GRD jack and positive lead to J2-3).	POWER switch in OFF position and rotate FUNCTION selector through 12 test positions. NOTE A coupler control module must not be used for this test.	Continuity in position 5 and 6 only.

Table 6-3. 878L-15 Antenna Coupler Control Tester, Diode Matrix Ground Test

Test point	FUNCTION Selector Position											
	1	2	3	4	5	6	7	8	9	10	11	12
J1-1		X	X									
J1-8			X			X			X	X		
J1-14			X									
J1-17		X		X						X	X	
J1-23			X			X			X	X		
J1-26		X	X							X		
J1-29					X	X	X	X	X	X		
J1-36	X											
J1-38				X	X							
J1-41										X	X	
J1-46						X	X	X	X	X	X	
J1-48										X	X	
J2-24								X				
Matrix terminal 50	100	170	110	110	X	X	170	170	110	110	110	170
Matrix terminal 51	2.8K	2.8K	2.8K	2.8K	2.8K	2.8K	2.8K	2.8K	2.8K	2.8K	X	2.8K
Matrix terminal 52	X	150	70	X	70	70	150	150	X	X	X	150
Matrix terminal 57						X	X	X				
Matrix terminal 58								X				
Matrix terminal 59	X	X	X	X	X	X	X	X	X		X	X
Matrix terminal 60	X	X	X	X	X	X	X	X	X	X	X	X

NOTE

An X indicates continuity *between* GRD jack and listed terminal, and a blank indicates infinite resistance. The numbers are resistances in ohms where continuity is not a short.

Table 6-4. 878L-15 Antenna Coupler Control Teeter, Diode Matrix 28-VDC Test

Test point	FUNCTION selector position											
	1	2	3	4	5	6	7	8	9	10	11	12
Matrix terminal 57	X	X	X	X	X				X	X	X	X
Matrix terminal 58	X	X	X	X	X	X	X		X	X	X	X
Matrix terminal 59										X		
Matrix terminal 60			X									
Matrix terminal 68	X	X		X	X	X			X	X	X	
Matrix terminal 69	3K	3K	3K	3K	X	X	X	X	X	X	3K	X
Matrix terminal 70	3K	3K	3K	3K	3K	3K	3K	3K	3K	X	3K	X
Matrix terminal 71	150	150	150	150	150	X	X	X	150	150	150	150
Matrix terminal 72	X	X	X		X	X			X	X		
Matrix terminal 73	X	150	X	X	150	150	150	150	X	X	X	150
Matrix terminal 74			X									

NOTE

An X indicates continuity between J2-29 and the listed terminal, and a blank indicates infinite resistance. The numbers are resistances in ohms where continuity is not a short.

Table 6-5. 878L-15 Antenna Coupler Control Tester, Troubleshooting Chart

Test step No.	Control settings	Trouble	Probable cause	Remedy
1	<p>POWER switch in ON position, FUNCTION selector in position 17 and KEY button depressed.</p> <p>NOTE A coupler control module must not be connected to the 878L-15.</p>	<p>No lamp indication.</p> <p>Not all lamps lighted.</p>	<p>Input power. POWER switch S1.</p> <p>FUNCTION selector (S2C front and rear). Transformer T1.</p> <p>Rectifier.</p> <p>Relay K1.</p> <p>Lamp.</p> <p>Switching diode.</p>	<p>Check 115-volt 400-Hz source. Check switch S1.</p> <p>Inspect switch contacts. Clean, repair, or replace switch as required.</p> <p>Check transformer windings for continuity.</p> <p>Test diodes CR1 and CR2 for open or short. Replace if faulty.</p> <p>Check operation of relay K1 replace if faulty.</p> <p>Test lamp for continuity. Replace if faulty.</p> <p>Test appropriate switching diode for continuity. Refer to figure FO-2 to aid in isolating faulty diode. Check SCR's CR3 and CR4 if lamps P1-31 and P2-22 are not lighted.</p> <p>NOTE P1-31 and P2-22 are switched by scr's CR3 and CR4. Check CR3 energizing circuit CR5,</p>

Table 6-5. 838L-15 Antenna Coupler Control Tester, Troubleshooting Chart-Continued

Test step No.	Control settings	Trouble	Probable cause	Remedy
2	<p>POWER switch in ON position and FUNCTION selector rotated through the 12 test position.</p> <p>NOTE</p> <p>A coupler control module must be connected to the 878L-15.</p>	Program (amber) lamps not lighted as indicated in table 2-1.	Matrix switching diodes	<p>R14, R20, C3 and CR4 energizing circuit CR6, R17, R21, C4.</p> <p>Replace faulty diode. Refer to figure FO-2 to aid in isolating faulty diode.</p>
2	<p>POWER switch in OFF position. Rotate FUNCTION selector through 12 test positions.</p> <p>NOTE</p> <p>A coupler control module must not be connected to the 878L-15.</p>	Continuity not as indicated in table 6-3.	Matrix switching diode.	Replace faulty diode. Refer to figure FO-2 to aid in isolating faulty diode.
4	<p>POWER switch in OFF position. Rotate FUNCTION selector through 12 test positions.</p> <p>NOTE</p> <p>A coupler control module must not be connected to the 878L-15.</p>	Continuity not as indicated in table 6-4.	Matrix switching	Replace faulty diode. Refer to figure FO-2 to aid in isolating faulty diode.
5	<p>POWER switch in OFF position. Rotate FUNCTION selector through 12 test positions.</p> <p>NOTE</p> <p>A coupler control module must not be connected to the 878L-15.</p>	Continuity not indicated.	KEY switch (S3). FUNCTION selector (S2A front).	Check switch S3. Inspect switch contacts. Clean, repair, or replace switch as required.
6	<p>POWER switch in OFF position and FUNCTION selector in positions 4, 7, 8, and 12. KEY buttons depressed at each setting of FUNCTION selector.</p>	Continuity not indicated.	KEY switch (S3). FUNCTION selector (S2A) front).	Check switch S3. Inspect switch contacts. Clean, repair, or replace switch as required.
7	<p>POWER switch in ON position and FUNCTION selector rotated through 12 test positions.</p> <p>NOTE</p> <p>A coupler control module must be connected to 878L-15.</p>	No output in positions 10 and 12.	CR70KK or CR70MM open.	Replace faulty diode.
		Output not in tolerance.	Resistor R5 or R6. Loss of 28 vdc.	Check value of resistors and replace if faulty.
		Output when FUNCTION selector is in position different from 10 or 12.	Matrix diode shorted.	Check CR33 and CR 34 in coupler control module. Replace faulty diode. Refer to figure FO-2 to aid in isolation of faulty diode.
8	POWER switch in OFF position	Continuity not in-	FUNCTION selector	Inspects switch contacts. Clean,

Table 6-5. 878L-15 Antenna Coupler Control Teeter, Troubleshooting Chart-Continued

Test step No.	Control settings	Trouble	Probable cause	Remedy
	and FUNCTION selector rotated through 12 test positions. NOTE A coupler control module must not be connected to the 878L-15.	icated.	(S2F front).	repair, or replace switch as required.
9	POWER switch in OFF position and FUNCTION selector rotated through 12 test positions. NOTE A coupler control module must not be connected to the 878L-15.	Continuity not indicated.	FUNCTION selector (S2F rear).	Inspect switch contacts. Clean, repair, or replace switch as required.
		Continuity indicated when FUNCTION selector in position different from 5 or 6.	CR50F or CR50F open. Matrix diode shorted.	Replace faulty diode. Replace faulty diode. Refer to figure FO-2 to aid in isolation of faulty diode.

6-3. 878L-16 Electronic control Amplifier Tester

a. Operational Test. The operational test for the 878L-16 is performed to insure that the indicator lamps and lamp circuits are functioning properly. The operational test procedures are described below.

- (1) Set FUNCTION selector (S1) to OFF.
- (2) Set power switch (S2) to SELF TEST.
- (3) All indicator lamps should be lighted and the TORQUE METER should indicate approximately 0.4 inch-ounce.

b. Minimum Performance Test. The minimum performance test for the 878L-16, described in table 6-6, consists of a series of tests performed on the test bench. Successful completion of the test will insure that the unit is functioning within acceptable limits of performance.

c. Troubleshooting Chart. A troubleshooting chart for the 878L-16 is provided in table 6-7. Fault indication is based on trouble encountered during the minimum performance and operational tests. The test steps of the troubleshooting chart are arranged in the same sequence as the test steps in the minimum performance test. If a fault occurs during minimum performance test refer to the corresponding step in the troubleshooting chart to determine probable cause and remedy.

d. Calibration. Subparagraphs (1), (2), and (3) below describe calibration procedures for the 878L-16. No adjustment or calibration procedures are required beyond those described.

N O T E

The 878L-16 must be connected to a 115vac, 400-Hz single-phase power source for the following adjustments.

(1) *Negative Error Adjustment.* Establish the proper operating setting of negative error potentiometer R10, as follows:

- (a) Set power switch (S2) to ON.
- (b) Set FUNCTION selector to position 1.
- (c) Adjust R10 for 0.212 ±0.01 volt dc at pin 33 of J1.

(2) *Positive Error Adjustment.* Establish the proper operating setting of positive error potentiometer R11, as follows:

- (a) Set power switch to ON.
- (b) Set FUNCTION selector to position 3.
- (c) Adjust R11 for 0.100 ±0.01 volt dc at pin 30 of J1.

(3) *TORQUE METER Adjustment.* Calibrate the TORQUE METER as follows:

- (a) Set FUNCTION selector (S1) to Off.
- (b) Set power switch (2) to SELF TEST.
- (c) Adjust position of spring on the motor plate for a total pointer deflection of 8 ±1 units (0.4 ±0.05 inch-ounce).
- (d) Set power switch (S2) to OFF.
- (e) Loosen four screws that secure motor plate to the mounting posts.
- (f) Position motor plate for a zero pointer indication.
- (g) Loosen pointer and position for zero indication if motor plate cannot be rotated to zero.
- (h) Repeat (b) through (f) above.

Table 6-6. 878L-16 Electronic Control Amplifier Tester, Minimum Performance Test

Step No.	Description of test	Test equipment	Control settings and instructions	Required indication
1	Initial test requirements.		Perform visual inspection of the 878L-16 as described in the inspection section. NOTE Unless otherwise specified all controls, indicators, and connectors referenced in this procedure are located on the 878L-16.	
2	Operation of K1. Negative error output to servo-amplifier A. Band information time delay ground. 8- to 16-MHz band information circuit. Input to TORQUE METER.	Ohmmeter Dc vtvm Ohmmeter Dc vtvm Ohmmeter	Power switch (S2) in ON position and FUNCTION selector (S1) in position 1.	Momentary ground at pin 7 of J1. -0.212 vdc at pin 33 of J1. Ground at pin 6 of J1. 18 vdc at pin 24 of J1. Continuity from J1 pin 2 to S2B rear contact 3 and from J1 pin 20 to S2B rear contact 7. 30 vac at pin 10 of J1. 9 to 13 vac.
3	30 vac. 9- to 13-vac. Positive error signal to servo-amplifier A. Power to tune B delay. Power to gate of RF switch. Band information time delay ground. 8- to 16-MHz band information circuit. Input to TORQUE METER.	Ac vtvm Ac vtvm Dc vtvm Dc vtvm Dc vtvm Ohmmeter	Check ac level at pin 37 of J1. Power switch (S2) in ON position and FUNCTION selector (S1) in position 2.	+0.075 vdc at pin 30 of J1. 28 vdc at pin 13 of J1 and ground at pin 14 of J1. 28 vdc at pin 9 of J1 and J1 pin 27. Ground on pin 6 of J1. 28 vdc at pin 24 of J1. Continuity from J1 pin 2 to S2B rear contract 7 and from J1 pin 20 to S2B rear contract 3. Momentary ground at pin 7 of J1. -0.075 vdc at pin 30 of J1.
4	Operation of K1. Positive error signal to servo-amplifier A. Tune B relay ground. Power to series varicoil damping relay. Band information time delay ground. 4- to 8-MHz band information circuit. Input to TORQUE METER.	Ohmmeter Dc vtvm Ohmmeter Dc vtvm Ohmmeter Dc vtvm Ohmmeter	Power switch (S2) in ON position and FUNCTION selector (S1) in position 3.	Ground at pin 14 of J1. 28 vdc at pin 36 of J1 and ground at pins 12 and 17 of J1. Ground at pin 6 of J1. 28 vdc at pin 8 of J1. Continuity from J1 pin 2 to S2B rear contact 7 and from J1 pin 20 to S2B rear contact 3.
5	Negative error signal to servo-amplifier A. Tune B relay ground. Gain change relay ground. Band information time delay ground. Reverse bias of tune B damping diode.	Dc vtvm Ohmmeter Ohmmeter Ohmmeter Ohmmeter	Power switch (S2) in ON position and FUNCTION selector (S1) in position 4.	-0.212 vdc at pin 30 of J1. Ground at pin 14 of J1. Ground at pin 15 of J1 and pin 29 of J1. Ground at pin 6 of J1. Ground at pin 17 of J1.

Table 6-6. 878L-16 Electronic Control Amplifier Tester, Minimum Performance Test—Continued.

Step No.	Description of test	Test equipment	Control settings and instructions	Required indication
6	4- to 8-MHz band information circuit. Input to TORQUE METER.	Dc vtvm Ohmmeter	Power switch (S2) in ON position and FUNCTION selector (S1) in position 5.	28 vdc at pin 8 of J1. Continuity from J1 pin 2 to S2B rear contact 3 and from J1 pin 20 to S2B rear contact 7.
	Operation of K1.	Ohmmeter		Momentary ground at pin 7 of J1.
	Ground input to servoamplifier A.	Ohmmeter		Ground on pin 30 of J1.
	Tune B relay ground.	Ohmmeter		Ground at pin 14 of J1.
	Band information time delay ground.	Ohmmeter		Ground at pin 6 of J1.
	Forward bias of tune B damping diode.	Dc vtvm		28 vdc at pin 17 of J1.
7	4- to 8- MHz band information circuit. Input to TORQUE METER	Dcvtvm Ohmmeter	Power switch (S2) in ON position and FUNCTION selector (S1) in position 7.	28 vdc at pin B of J1. Continuity from J1 pin 2 to S2B rear contact 3 and from J1 pin 20 to S2B rear contact 7.
	Operation of K1.	Ohmmeter		Momentary ground at pin 7 of J1.
	Negative error signal to servoamplifier B.	Dc vtvm		-0.212 vdc to pin 30 of J1.
	Band information time delay ground.	Ohmmeter		Ground at pin 6 of J1.
	RF switch gate to anode short.	Ohmmeter		Ground at pin 9 of J1.
	8- to 16- MHz band information circuit. Input to TORQUE METER.	Dc vtvm Ohmmeter		28 vdc at pin 24 of J1. Continuity from J1 pin 21 to S2B rear contact 3 and from J1 pin 22 to S2B rear contact 7.
8	Ground input to servoamplifier B.	Ohmmeter	Power switch (S2) in ON position and FUNCTION selector (S1) in position B. Power switch (S2)	Ground at pin 33 of J1.
	Tune B relay ground.	Ohmmeter		Ground at pin 14 of J1.
	Band information time delay ground.	Ohmmeter		Ground at pin 6 of J1.
	8- to 16- MHz band information circuit.	Dc vtvm		28 vdc at pin 24 of J1.
	Input to TORQUE METER.	Ohmmeter		Continuity from J1 pin 21 to S2B rear contact 7 and from J1 pin 22 to S2B rear contact 3.
	Conduction of RF switch.	Dc vtvm		28 vdc at pin 9 of J1.
9	Operation of K1.	Ohmmeter	Power switch (S2) in ON position and FUNCTION selector (S1) in position 9.	Momentary ground at pin 7 of J1.
	Positive error signal to servoamplifier B.	Dc vtvm		+0.075 vdc at pin 33 of J1.
	16- to 30- MHz band information circuit.	Dc vtvm		28 vdc at pin 23 of J1.
	Input to TORQUE METER.	Ohmmeter		Continuity from J1 pin 21 to S2B rear contact 3 and from J1 pin 22 to S2B rear contact 7.
	Band information time delay ground.	Ohmmeter		Ground at pin 6 of J1.
	Operation of RF switch.	Ohmmeter		Ground at pin 9 of J1.
10	Variable negative error signal to servoamplifier A.	Dc vtvm	Power switch (S2) in ON position, FUNCTION selector (S1) in position 10, and VAR INPUT rotated from 0 to SAT position.	0 vdc at pin 32 of J1.

Table 6-6. 878L-16 Electronic Control Amplifier Tester, Minimum Performance Test-Continued.

Step No.	Description of test	Test equipment	Control settings and instructions	Required indication
11	Band information time delay ground.	Ohmmeter	SAT	1 vdc at pin 32 of J1.
	Input to TORQUE METER.	Ohmmeter		Ground at pin 6 of J1.
	16- to 30- MHz band information circuit.	Dc vtmv		Continuity from J1 pin 2 to S2B rear contact 3 and from J1 pin 20 to S2B rear contact 7.
	Variable negative error signal to servoamplifier B.	Dc vtmv		28 vdc at pin 23 of J1.
12	Input to TORQUE METER.	Ohmmeter	Power switch (S2) in ON position, FUNCTION selector (S1) in position 11, and VAR INPUT rotated from 1 to SAT.	0 vdc at pin 31 of J1.
	4 to 8-MHz band information circuit.	Dc vtmv	0	1 vdc at pin 31 of J1.
	8 to 16-MHz band information circuit.	Dc vtmv	SAT	Continuity from J1 pin 21 to S2B rear contact 7 and from J1 pin 22 to S2B rear contact 3.
	16 to 30-MHz band information circuit.	Dc vtmv		28 vdc at pin 8 of J1.

Table 6-7. 878L-16 Electronic Control Amplifier Tester, Troubleshooting Chart

Test step	Circuit selector position	Trouble	Probable cause	Remedy
1	FUNCTION selector (S1) in OFF position. Power switch (S2) in SELF TEST position.	Not all indicator lamps lighted.	Burned-out lamps. Power switch S2A.	Replace faulty lamp. Inspect switch contacts. Clean, repair, or replace switch as required.
		No meter indication.	Resistors R15 through R27 open or shorted. Source power. Capacitor C5, C6, or C8 shorted. Meter M1 open or shorted windings. Power switch S2B	Test component values. Replace faulty components. Check output from transformer T1. Check meter connections. Test component values. Replace faulty components. Check continuity of motor windings. Replace faulty motor. Inspect switch contacts. Clean, repair, or replace switches as required.
2	Power switch (S2) in ON position FUNCTION selector (S1) in position 1.	No lamp indication.	Burned-out fuse. Power supply.	Check fuse F2. Test component values (CR1, CR2, C1, R1, T1). Replace faulty components.
		No ground at J1-7.	Relay K1. Resistor R13, R14, open or shorted or capacitor C3, C4 shorted. FUNCTION selector S1F rear. Connector J1. Loose, broken, or faulty contact. Potentiometer R11.	Check relay for coil continuity and stuck or burnt contacts. Replace faulty relay. Test component values. Replace faulty components. Input switch contacts. Clean, repair, or replace switch as required. Repair or replace. Adjust as described in paragraph 6-3d.
		Output at J1-33 not within tolerance.		

Table 6-7. 878616 Electronic Control Amplifier Teeter, Troubleshooting Chart-Continued

Test step	Circuit selector position	Trouble	Probable cause	Remedy
		No output at J1-33.	Power supply. FUNCTION selector S1A front and S1B front.	Test component values (R28, CR4, C7, R4, R5, R7, CR2, R9, R11). Replace faulty component. Input switch contacts. Clean, repair, or replace switches as required.
		Connector J1-6 not grounded.	Connector J1. Loose, broken, or faulty contact. FUNCTION selector S1B rear.	Repair or replace. Inspect switch contacts. Clean, repair, or replace switches as required.
		No output at J1-10.	Power supply. Connector J1. Loose, broken, or faulty contact.	Check T1. Repair or replace.
		No output at J1-37. Open circuit to TORQUE METER.	Power supply. FUNCTION selector S1C front and S1D front. Power switch S2B rear. Connector J1. Loose, broken, or faulty contact.	Check T1 and L1. Inspect switch contacts. Clean, Repair, or replace switches as required. Repair or replace.
3	Power switch (S2) in ON position and FUNCTION selector (S1) in position 2.	Output at J1-30 not within tolerance. Not output of J1-30. Connector J1-6 not grounded. No output at J1-24. Open circuit to TORQUE METER. No output at J1-13. Connector J1-14 grounded. No output at J1-9.	Potentiometer R11. Power supply. FUNCTION selector S1A front and S1B front. Connector J1. Loose, broken, or faulty contact. FUNCTION selector S1B rear. Connector J1. Loose, broken, or faulty contact. Connector J1. Loose, broken, or faulty contact. FUNCTION selector S1C front and S1D front. Power switch S2B rear. Connector J1. Loose, broken, or faulty contact. FUNCTION selector S1F rear. Connector J1. Loose, broken, or faulty contact. FUNCTION selector S1A rear. Connector J1. Loose, broken, or faulty contact. FUNCTION selector S1F S1F front. Connector J1. Loose, broken, or faulty contact.	Adjust as described in paragraph 6-3d. Test component values (R28, CR4, R4, R5, R7, CR2, R9, R11). Replace faulty component. Inspect switch contacts. Clean, Repair, or replace switches as required. Repair or replace. Inspect switch contacts. Clean, repair, or replace switches as required. Repair or replace. Repair or replace. Inspect switch contacts. Clean, repair or replace switches as required. Repair or replace. Inspect switch contacts. Clean, repair, or replace switches as required. Repair or replace. Inspect switch contacts. Clean, repair, or replace switches as required. Repair or replace.

Table 6-7. 878L-16 Electronic Control Amplifier Tester, Troubleshooting Chart-Continued

Test step	Circuit selector position	Trouble	Probable cause	Remedy
		No output at J1-27.	Power switch S2B front.	Inspect switch contacts. Clean, repair, or replace switch as required.
4	Power switch (S2) in ON position and FUNCTION selector (S1) in position 3.	No ground at J1-7.	Relay K1. Resistor R13, R14 open or shorted, or capacitor C3, C4 shorted. FUNCTION selector S1F rear.	Check relay for coil continuity and stuck or burnt contacts. Replace faulty relay. Test component values. Replace faulty components. Inspect switch contacts. Clean, repair, or replace switch as required.
		Output at J1-30 not within tolerance.	Connector J1. Loose, broken, or faulty contact. Potentiometer R11.	Repair or replace. Adjust as described in paragraph 6-3d.
		No output at J1-30.	Power supply. FUNCTION selector S1A front and S1B front.	Test component values (R28, CR4, C7, R4, R5, R7, CR8, R9, R11). Replace faulty equipment. Inspect switch contacts. Clean, repair, or replace switches as required.
		Connector J1-6 not grounded.	FUNCTION selector S1B rear. Connector J1. Loose, broken, or faulty contact.	Inspect switch contacts. Clean, repair, or replace switches as required. Repair or replace.
		No output at J1-8.	Connector J1. Loose, broken, or faulty contact.	Check T1 and L1. Repair or replace.
		Open circuit to TORQUE METER.	FUNCTION selector S1C front and S1D front.	Inspect switch contacts. Clean, repair, or replace switch as required.
		Connector J1-14 not grounded.	Power switch S2B rear. Connector J1. Loose, broken, or faulty contact.	Repair or replace. Inspect switch contacts. Clean, repair, or replace switches as required.
		No output at J1-36.	FUNCTION selector S1A rear. Connector J1. Loose, broken, or faulty contact.	Repair or replace. Repair or replace.
		Connector J1-12 not grounded.	Connector J1. Loose, broken, or faulty contact. FUNCTION selector S1E rear.	Inspect switch contacts. Clean, repair, or replace switches as required. Repair or replace.
		No output at J1-36.	Connector J1. Loose, broken, or faulty contact.	Repair or replace.
		Connector J1-12 not grounded.	Connector J1. Loose, broken, or faulty contact. FUNCTION selector S1E rear.	Inspect switch contacts. Clean, repair, or replace switches as required. Repair or replace.
		Connector J1-17 not grounded.	Connector J1. Loose, or broken, or faulty contact. FUNCTION selector S1F front.	Inspect switch contacts. Clean, repair, or replace switches as required.
			Power switch S2B front. Connector J1. Loose, broken, or faulty contact.	Repair or replace.
5	Power switch (S2) in ON position and FUNCTION selector in position 4.	Output at J1-30 not within tolerance.	Potentiometer R10.	Adjust as described in paragraph 6-3d.
6-12				

Table 6-7. 878L-16 Electronic Control Amplifier Test Troubleshooting Chart--Continued.

Test step	Circuit selector position	Trouble	Probable cause	Remedy
		No output at J1-30.	Power supply.	Test component values (R28, CR3, C2, R2, R3, R6, CR1, R8, R10). Replace faulty equipment.
		Connector J1-6 not grounded.	FUNCTION selector S1A front and S1B front.	Input switch contacts. Clean, repair, or replace switches as required.
		No output at J1-28.	Connector J1. Loose, broken, or faulty contact.	Repair or replace.
		Open circuit to TORQUE METER.	FUNCTION selector S1B rear.	Inspect switch contacts. Clean, repair, or replace switches as required.
		Connector J1-14 not grounded.	Connector J1. Loose, broken, or faulty contact.	Repair or replace.
		Connector J1-15 not grounded.	Connector J1. Loose, broken, or faulty contact.	Repair or replace.
		Connector J1-29 not grounded.	FUNCTION selector S1C front and S1D front.	Inspect switch contacts. Clean, repair, or replace switches as required.
		J1-17 not grounded.	Power switch S2B rear.	Repair or replace.
			Connector J1. Loose, broken, or faulty contact.	Repair or replace.
			FUNCTION selector S1A rear.	Inspect switch contacts. Clean, repair, or replace switches as required.
			FUNCTION selector S1E rear.	Inspect switch contacts. Clean, repair, or replace switches as required.
			Connector J1. Loose, broken, or faulty contact.	Repair or replace.
			Connector J1. Loose, broken, or faulty contact.	Repair or replace.
			FUNCTION selector S1F front power switch S2B front.	Inspect switch contacts. Clean, repair, or replace switches as required.
			Connector J1. Loose, broken, or faulty contact.	Repair or replace.
6	Power switch (S2) in ON position and FUNCTION selector in position 5.	No ground at J1-7.	Relay K1.	Check relay for coil continuity and stuck or burnt contacts. Replace faulty relay.
			Resistor R13, R14 open or shorted, or capacitor, C3, C4 shorted.	Test component values, Replace faulty components.
			FUNCTION selector S1F rear.	Inspect switch contacts. Clean, repair, or replace switch as required.
			Connector J1. Loose, broken, or faulty contact.	Repair or replace.
		Connector J1-30 not grounded.	FUNCTION selector S1A front and S1B front.	Inspect switch contacts. Clean, repair, or replace switches as required.
			Connector J1. Loose, broken, or faulty contact.	Repair or replace.
		Connector J1-6 not grounded.	FUNCTION selector S1B rear.	Inspect switch contacts. Clean, repair, or replace switches as required.
			Connector J1. Loose, broken, or faulty contact.	Repair or replace.
		No output at J1-8.	Connector J1. Loose, broken, or faulty contact.	Repair or replace.
		Open circuit to TORQUE METER.	FUNCTION selector S1C front and S1D front.	Inspect switch contacts. Clean, repair, or replace switches as required.
			Power switch S2B rear.	

Table 6-7. 878L-16 Electronic Control Amplifier Teeter, Troubleshooting Chart-Continued

Test step	Circuit selector position	Trouble	Probable cause	Remedy
		Connector J1-14 not grounded.	Connector J1. Loose, broken or faulty contact.	Repair or replace.
		No output at J1-17.	FUNCTION selector S1A rear. Connector J1. Loose, broken, or faulty contact. FUNCTION selector S1F front.	Inspect switch contacts. Clean, repair, or replace switches as required. Repair or replace. Inspect switch contacts. Clean, repair, or replace switches as required.
			Power switch S2B front. Connector J1. Loose, broken, or faulty contact.	Repair or replace.
7	Power switch (S2) in ON position and FUNCTION selector in position 7.	No ground at J1-17.	Relay K1.	Check relay for coil continuity and stuck or burnt contacts. Replace faulty relay.
			Resistor R13, R14 open or shorted, or capacitor C3, C4 shorted.	Test component values. Replace faulty components.
			FUNCTION selector S1F rear.	Inspect switch contacts. Clean, repair, or replace switch as required.
			Connector J1. Loose, broken, or faulty contact.	Repair or replace.
		Output at J1-30 not within tolerance.	Potentiometer R10.	Adjust as described in paragraph 6-3d.
		No output at J1-30.	Power supply.	Test component values (R28, CR3, C2, R2, R3, R6, CR1, R8, R10). Replace faulty component.
			FUNCTION selector S1A front and S1B front.	Inspect switch contacts. Clean, repair, or replace switches as required.
		Connector J1-6 not grounded.	Connector J1. Loose, broken, or faulty contact.	Repair or replace.
			FUNCTION selector S1B rear.	Inspect switch contacts. Clean, repair, or replace switches as required.
			Connector J1. Loose, broken, or faulty contact.	Repair or replace.
		No output at J1-24.	Connector J1. Loose, broken, or faulty contact.	Repair or replace.
		Open circuit to TORQUE METER.	FUNCTION selector S1C front and S1D front.	Inspect switch contacts. Clean, repair, or replace switches as required.
			Power switch S2B rear.	Repair or replace.
			Connector J1. Loose, broken, or faulty contact.	Repair or replace.
		Connector J1-9 not grounded.	FUNCTION selector S1F front.	Inspect switch contacts. Clean, repair, or replace switches as required.
			Connector J1. Loose, broken, or faulty contact.	Repair or replace.
8	Power switch (S2) in ON position and FUNCTION selector in position 8.	Connector J1-33 not grounded.	FUNCTION selector S1A front and S1B front.	Inspect switch contacts. Clean, repair, or replace switches as required.
			Connector J1. Loose, broken, or faulty contact.	Repair or replace.
		Connector J1-6 not grounded.	FUNCTION selector S1B rear.	Inspect switch contacts. Clean, repair, or replace switches as required.
			Connector J1. Loose,	Repair or replace.

Table 6-7. 878L-16 *Electronic Control Amplifier Tester, Troubleshooting Chart-Continued*

Test step	Circuit selector position	Trouble	Probable cause	Remedy
		No output at J1-24. Open circuit to TORQUE METER.	broken, or faulty contact. Connector J1. Loose, broken, or faulty contact. FUNCTION selector S1C front and S1D front.	Repair or replace. Inspect switch contacts. Clean, repair, or replace switches as required.
		Connector J1-14 not grounded.	Power switch S2B rear. Connector J1. Loose, broken, or faulty contact. FUNCTION selector S1A rear.	Repair or replace. Inspect switch contacts. Clean, replace or replace switches as required.
		No output at J1-9.	Connector J1. Loose, broken, or faulty contact. FUNCTION selector S1D rear.	Repair or replace. Inspect switch contacts. Clean, repair, or replace switches as required.
			Power switch S2B front. Connector J1. Loose, broken, or faulty contact.	Repair or replace.
9	Power switch (S2) in ON position and FUNCTION selector in position 9.	No ground at J1-7.	Relay K1. R18, R14 open or shorted, or C3, C4 shorted. FUNCTION selector S1F rear. Power switch S2B front. Connector J1. Loose, broken, or faulty contact.	Check relay for coil continuity and stuck or burnt contacts. Replace faulty relay. Test component values. Replace faulty components. Inspect switch contacts. Clean, repair or replace switch as required. Repair or replace.
10	Power switch (S2) in ON position and FUNCTION selector in position 10.	Output at J1-32 not within tolerance. Connector J1-6 not grounded. No output at J1-23. Open circuit to TORQUE METER. Output at J1-33 not within tolerance. No output at J1-33.	Power supply. FUNCTION selector S1A front and S1B front. Connector J1. Loose, broken, or faulty contact. FUNCTION selector S1B rear. Connector J1. Loose, broken, or faulty contact. Connector J1. Loose, broken, or faulty contact. FUNCTION selector S1C front and S1D front. Connector J1. Loose, broken, or faulty contact. Potentiometer R11. Power supply. FUNCTION selector S1A front and S1B front. Connector J1. Loose, broken, or faulty contact.	Test component values (R28, CR3, C2, R2, R3, R6, CR1, R8, R12). Replace faulty component. Inspect switch contacts. Clean, repair, or replace switches as required. Repair or replace. Inspect switch contacts. Clean, repair, or replace switches as required. Repair or replace. Repair or replace. Inspect switch contacts. Clean, repair, or replace switches as required. Repair or replace. Adjust as described in paragraph 6-3d. Test component values (R28, CR4, C7, R4, R5, R7, CR2, R9, R11). Replace faulty component. Inspect switch contacts. Clean, repair, or replace switches as required. Repair or replace.

Table 6-7. 878L-16 Electronic Amplifier Tester, Troubleshooting Chart-Continued

Test step	Circuit selector position	Trouble	Probable cause	Remedy
		Connector J1-6 not grounded.	FUNCTION selector S1B rear.	Inspect switch contacts. Clean, repair, or replace switches as required.
		No output at J1-23. Open circuit to TORQUE METER.	Connector J1. Loose, broken, or faulty contact. Connector J1. Loose, broken, or faulty contact. FUNCTION selector S1C front and S1D front.	Repair or replace. Repair or replace. Inspect switch contacts. Clean, repair, or replace switches as required.
		No output at J1-9.	Power switch S2B rear. Connector J1. Loose, broken, or faulty contact. FUNCTION selector S1D rear. Power switch S2B rear. Connector J1. Loose, broken, or faulty contact.	Repair or replace. Inspect switch contacts. Clean, repair, or replace switches as required. Repair or replace.
11	Power switch (S2) in ON position and FUNCTION selector in position 11.	Output at J1-31 not within tolerance. Open circuit to TORQUE METER.	Power supply. FUNCTION selector S1A front and S1B front. FUNCTION selector S1C front and S1D front. Power switch S2B rear. Connector J1. Loose, broken, or faulty contact.	Test component values (R28, CR3, C2, R2, R3, R6, CR1, R8, R12). Replace faulty component. Inspect switch contacts. Clean, repair, or replace switches as required. Inspect switch contacts. Clean, repair, or replace switches as required. Repair or replace.
12	Power switch (S2) in ON or SELF TEST position and FUNCTION selector in OFF position.	No output at J1-8. No output at J1-23. No output at J1-24.	Connector J1. Resistor R22 or lamp DS11 open. Connector J1. Resistor R24 or lamp DS8 open. Connector J1. Resistor R25 or lamp DS9 open.	Loose, broken, or faulty contact. Repair or replace. Check both components and replace if necessary. Loose, broken, or faulty contact. Repair or replace. Check both components, and replace if necessary. Loose, broken, or faulty contact. Repair or replace. Check both components and replace if necessary.

6-4. 878L-17 Discriminator Tester

a. Minimum Performance Test. The minimum performance test for the 878L-17, described in table 6-8, consists of a series of tests performed on the test bench. Successful completion of the tests will insure that the unit is functioning within acceptable limits of performance.

b. Troubleshooting Chart. A troubleshooting chart for the 878L-17 is provided in table 6-9. Fault indication is based on trouble encountered during the minimum performance tests. The test steps of the troubleshooting chart are arranged in the same sequence as the test steps in the minimum performance test. If fault occurs during minimum performance test refer to the corresponding step in the troubleshooting chart to determine probable cause and remedy.

c. Calibration. Subparagraphs (1) and (2) below provide calibration procedures for 878L-17 Discriminator Tester. No adjustment or

calibration procedures are required beyond those described.

(1) **Input power adjustment.** Establish the proper operating level of input power potentiometer R2 as follows:

(a) Set CIRCUIT SELECTOR to INPUT POWER.

(b) Connect a coaxial jumper from J2 to J3.

(c) Connect transmitter output to J1 and adjust transmitter frequency to 2 **MHz**.

(d) Key the transmitter and adjust for 70-volt RF output.

(e) Adjust R2 for a METER indication of 7 units.

(2) **LOAD adjustments.** Establish the proper operating level of capacitor C7 as follows:

(a) Set CIRCUIT SELECTOR to **PHASE**.

(b) Connect impedance bridge of J3.

(c) Adjust C7 for zero capacitance indication when dust cover is in place.

★ U.S. GOVERNMENT PRINTING OFFICE: 1990-665-119/1036

Table 6-8. 878L-17 Discriminator Tester, Minimum Performance Test

Step No.	Description of test	Test equipment	Control settings and instructions	Reqd indication
1	Initial test requirements.		<p>Perform a visual inspection of the 878L-17 as described in the inspection section.</p> <p>NOTE</p> <p>Unless otherwise specified all controls, indicators, and connectors referenced in this procedure are located on the 878L-17.</p>	
2	Input power.	Transmitter.	<p>a. Condition the CIRCUIT SELECTOR to the INPUT POWER position.</p> <p>b. Connect transmitter output to J1.</p> <p>c. Adjust transmitter frequency to 2 MHz.</p> <p>d. Key transmitter and adjust output to 70 volts.</p> <p>e. Switch transmitter key to off. Disconnect transmitter from J1.</p>	7 meter divisions.
3	Sensitivity.	Impedance bridge.	<p>a. Remove coaxial jumper from 50-ohm load (R5) at P1.</p> <p>b. Connect P1 to the capacitor bridge.</p> <p>c. Set CIRCUIT SELECTOR switch to PHASE position and measure the C_p (capacitance) with the capacity bridge, and note reading.</p> <p>d. Condition the CIRCUIT SELECTOR to 2 MHz, 8 MHz, 14 MHz, and 30 MHz positions in succession and observe capacitor bridge indicators for each position. Subtract the reading in c above from above readings to obtain required indications:</p> <p style="padding-left: 40px;">2 MHz 8 MH 14 MH 30 MH</p> <p>e. Disconnect the impedance bridge from the 878L-17.</p>	<p>Reference indications.</p> <p>348 to 418 pf 84 to 104 pf 48 to 60 pf 21 to 27 pf</p>
4	METER calibration check.	Dc power supply.	<p>a. Condition the CIRCUIT SELECTOR in the PHASE position.</p> <p>b. Apply a 250-mv dc signal to J4 pin 2. Observe</p>	9 to 11 meter divisions.

Table 6-8. 878L-17 Discriminator Tester, Minimum Performance Test-Continued

Step No.	Description of test	Test equipment	Control settings and instructions	Required indication
			<p>METER (M1).</p> <p>c. Condition the CIRCUIT SELECTOR in LOAD position.</p> <p>d. Apply a 250-mv dc signal to J4 pin 1. Observe METER (M1).</p> <p>e. Condition the CIRCUIT SELECTOR in the FWD POWER position.</p> <p>f. Apply a 5-vdc signal to J4 pin 6. Observe METER (M1).</p> <p>g. Condition the CIRCUIT SELECTOR in the REFL POWER position.</p> <p>h. Apply 1-vdc signal to J4 pin 5. Observe METER (M1).</p>	<p>9 to 11 meter divisions.</p> <p>9 to 11 meter divisions.</p> <p>9 to 11 meter divisions.</p>

Table 6-9. 878L-17 Discriminator Tester, Troubleshooting Chart

Test Step No.	Circuit selector position	Trouble	Probable cause	Remedy
1	Refer to inspection section for visual inspection test.			
2	INPUT POWER.	<p>No METER (M1) indication.</p> <p>METER indications out of tolerance.</p>	<p>Source RF.</p> <p>Power detector: C1, C2, C3, CR1, R1, R2, R4.</p> <p>CIRCUIT SELECTOR switch (S1A, S1C).</p> <p>METER circuit: R16, R17, C15, M1.</p> <p>Potentiometer R2.</p>	<p>Check source RF output, check RF interconnect cable.</p> <p>Test for open or shorted component. Replace faulty component.</p> <p>Inspect switch contacts. Clean, repair, or replace switch as required.</p> <p>Check for secure connections at meter. Test for open or shorted components. Replace faulty components.</p> <p>Readjust (para 6-4c).</p>
3	<p>PHASE SENS.</p> <p>2-MHz</p> <p>8-MHz</p> <p>14-MHz</p> <p>30-MHz</p>	<p>Capacitor bridge indication (sensitivity) out of tolerance.</p> <p>Capacitor bridge indication (sensitivity) out of tolerance.</p> <p>Capacitor bridge indication (sensitivity) out of tolerance.</p> <p>Capacitor bridge indication (sensitivity) out of tolerance.</p>	<p>Capacitor C13, C14.</p> <p>Capacitor C11, C12.</p> <p>Capacitor C9, C10.</p> <p>Capacitor C5, C6.</p>	<p>Replace faulty component.</p> <p>Replace faulty component.</p> <p>Replace faulty component.</p> <p>Replace faulty component.</p>

Table 6-9. 878L-17 Discriminator Tester, Troubleshooting Chart-Continued

Test Step No.	Circuit selector position	Trouble	Probable cause	Remedy
	PHASE.	sitivity) out of tolerance. Capacitor bridge indication (sensitivity) out of tolerance.	Capacitor C7.	Readjust (para 6-4c).
4	PHASE.	METER (M1) indication out of tolerance. No indication.	Resistor R8, R9. CIRCUIT SELECTOR switch S1C. Connector J4. Loose, broken, or faulty contact. Resistor R8, R9 open. METER circuit.	Test component values. Replace component if required. Inspect switch contacts. Clean, repair, or replace switch as required. Repair or replace. Replace faulty equipment. Check meter connections. Test meter circuit components for shorts or opens. Replace components.
	LOAD.	METER indication out of tolerance. No indication.	Potentiometer R10, R11. CIRCUIT SELECTOR switch S1C. Connector J4. Loose, broken, or faulty contact. Potentiometer R10, R11 open. METER circuit.	Test component values. Replace faulty component. Inspect switch contacts. Clean repair, or replace switch as required. Repair or replace. Replace faulty component. Check meter connections. Test meter circuit components for short or opens. Replace faulty components.
	FWD POWER.	METER indication out of tolerance. No indication.	Potentiometer R3, R14, R15. CIRCUIT SELECTOR switch S1C. Connector J4. Loose, broken, or faulty contact. Resistor R3 shorted, R14, R15 open. METER circuit.	Test component values. Replace faulty components. Inspect switch contacts. Clean, repair, or replace switch as required. Repair or replace. Replace faulty component. Check meter connections. Test meter circuit components for opens or shorts. Replace faulty components.
	REFL POWER.	METER indication out of tolerance. No indication.	Potentiometer R1, R12, R13. CIRCUIT SELECTOR switch S1C. Connector J4. Loose, broken, or faulty contact. Resistor R1 shorted, R12, R13 open. METER circuit.	Test component values. Replace faulty component. Inspect switch contacts. Clean, repair, or replace as required. Repair or replace. Replace faulty component. Check meter connections. Test meter circuit components for opens or shorts. Replace faulty components.

6-5. Troubleshooting and Repair of Transistorized Circuits

When troubleshooting and repairing transistor circuits, observe the following factors:

a. In a transistor amplifier any change in the output circuit of one stage can affect all preceding stages. Therefore, any deviation in the operating characteristics of a certain stage can be reflected back to affect the operation of the preceding stages.

b. Common-emitter transistor amplifiers have a 180-degree phase shift between the input and output voltages. However, there will be no phase shift between the input and output signals if the base is shorted to the collector of the transistor.

c. The dc base voltage should be slightly higher than the emitter voltage during normal operation of a common-emitter transistor amplifier. However, an open circuit between the base and the emitter of the transistor will result in the emitter voltage approximating ground potential and a base voltage considerably greater than normal.

d. An unusually high dc collector voltage can be caused by an open emitter circuit, an open collector circuit, or a short between the base and the emitter of the transistor. However, an open circuit between either the base and the emitter or in the load impedance of the stage under consideration will also cause an unusually high dc collector voltage.

e. An unusually low dc collector voltage indicates a short circuit between the collector and ground, the collector and the emitter, the collector and the base, or across the output impedance.

(1) An unusually low collector voltage results when a transistor switch is activated. Therefore, when +28 volts dc is applied to the base circuit of Q3, Q5, Q6, or Q7 in the coupler control module, the collector voltage should be nearly zero.

(2) **When** checking the base-to-emitter resistance of the npn type of transistor, the ground of the voltohmyst must be connected to the emitter lead. The resistance indicated on the RX1 scale then should be greater than 10 ohms but less than 50 ohms. However, when the meter leads are reversed, the indicated emitter-to-base resistance will be several thousand times greater.

(3) **When** soldering transistor leads to terminal points, use the same precautions normally followed when working with crystal diodes.

C A U T I O N

When soldering transistor leads, use pliers as a heat sink by holding them between the transistor and the point of heat application to divert the heat from the transistor.

f. Use a 35-watt iron to solder or unsolder all connections except ground connections made directly to the chassis. For ground connections to a chassis, use a 100-watt iron.

Table 6-10. Typical Electronic Control Amplifier Transistor Voltage

Transistor	Base	Emitter	Collector
Q1	5.1	0	14.0
Q2	1.2	0.5	12.0
Q3	22.0	23.0	30.0
Q4	22.0	23.0	30.0
Q5	23.0	23.0	23.0
Q6	23.0	23.0	23.0
Q7	5.1	0	14.0
Q8	1.2	0.5	12.0
Q9	22.0	23.0	30.0
Q10	22.0	23.0	30.0
Q11	23.0	23.0	23.0
Q12	23.0	23.0	23.0

NOTE

These measurements made with the 878L-16 function selector in position 5.

6-6. Cleaning of Dismantled Module Tester

a. General. Wherever practical, instructions are given for cleaning the dismantled 878L-51 16/17 module tester. Instructions are in tabular form, arranged to facilitate reference by paragraph to the procedure for cleaning the various parts. All parts requiring particular methods of cleaning are considered separately, and part which are similar enough to permit identical cleaning procedures are grouped. The use of the word solvent in the following procedures means Turcosol or Stoddard solvent. Other materials required: chamois skin, lint-free cloth, detergent powder, lens tissue paper, bearing cleaning machine.

WARNING

Perform operation involving cleaning solvent under a ventilated hood. Avoid breathing solvent vapor and fumes; wear a suitable mask when necessary. Avoid continuous contact with the solvent. Use goggles, gloves, and apron to prevent irritation due to prolonged contact. Change clothing that has become saturated with solvent.

b. References to air jet in this section indicates a hand-operated air nozzle supplied with clean and dry compressed air at a pressure of 28 pounds per square inch maximum.

W A R N I N G

Wear goggles when using the air jet to blow dust and dirt from equipment parts. Warn other persons away from hazardous area of working enclosure.

6 - 7 . C l e a n i n g P r o c e d u r e s

Subparagraphs *a* through *j* below contain instructions and procedures for cleaning the various parts of the dismantled 878L-15/16/17 module tester.

a. Cables, Covered.

(1) Clean outer surfaces of vinylite conduit by wiping dirt from surfaces with a solvent-moistened lint-free cloth.

(2) Wipe dry using a clean, dry, lint-free cloth.

(3) Treat any connector terminations directed in *c.* below. Wipe lug terminations clean with a solvent-moistened, lint-free cloth. Dry with a clean, dry, lint-free cloth.

b. Chassis, Wired. The following cleaning procedures should be used for chassis containing terminal boards, resistor and capacitor assemblies, RF coils, switches, inductors, transformers, and other wired parts.

(1) Remove dust and dirt from all surfaces, including parts and wiring, using soft-bristled brushes in conjunction with an air jet.

CAUTION

Avoid air-blasting small coils, leads, and other delicate parts by holding air jet nozzle too close. Be careful when using brush on delicate parts.

NOTE

When necessary to disturb the dress of wiring and cables, dressing should be noted, and wiring and cables restored to positions and dress after cleaning is completed.

(2) Clean jacks as instructed in *e* below.

(3) With minimum disturbance of wiring, clean connectors as instructed in *c* below.

(4) Clean wafer switches as instructed in *j* below.

(5) Complete chassis cleaning by wiping

down all finished surfaces with a solvent-moistened, lint-free cloth.

(6) Dry and polish these surfaces, using a dry, clean, lint-free cloth.

(7) Protect the chassis from dust, moisture, and damage, while awaiting inspection.

c. Connectors.

(1) Wipe dust and dirt from bodies, shells, and cable clamps, using a solvent-moistened, lint-free cloth. Wipe dry with a clean, dry, lint-free cloth.

(2) Remove dust from inserts using a small, soft-bristled brush and the air jet.

(3) Wash dirt and any traces of lubricant from inserts insulation, and contacts using a solvent applied sparingly with a small, camel's-hair brush.

CAUTION

Do not allow solvent to run into sleeves or conduit covering any wires or cables connected to contract terminals of the inserts.

(4) Dry the insert with air jet.

d. Covers. Clean all dust covers as follows:

(1) Remove bulk or surface grease with rags.

(2) Blow dust from surfaces, holes, and recesses using the air jet.

(3) Immerse cover in washing bath of solvent, and scrub until clean. Work over all surfaces and into all holes and recesses with a suitable nonmetallic brush. Flat, wood-backed brushes with soft fiber bristles are recommended for flat surfaces; round brushes (similar to those used for washing bottles and test tubes) are recommended for holes and recesses.

(4) Raise the cover from the bath, and permit solvent to drain into bath.

(5) Immerse in rinsing bath of cleaning solvent, rinse, and raise from bath. Position the cover to drain dry so that solvent is not trapped in holes or recesses. When practical positioning will not permit complete draining, use the air jet to blow out any trapped solvent.

(6) When thoroughly dry, touch up any minor damage to finish. Extensive damage to finish may require complete refinishing.

(7) Protect the cover from dust and moisture while awaiting inspection.

e. Jacks.

(1) Remove dust from exteriors with a camel's-hair brush and the air jet.

(2) Blow dust from interior of female contact with the air jet.

f. Machined Metal Parts. Detached shafts, keys, pins, spring and similar machined parts should be cleaned in suitable cleaning machine, if available, otherwise, proceed as follows:

- (1) Remove bulk or surface grease with rags.
- (2) Immerse part in washing bath of solvent, and scrub until clean, working over all surfaces and into all holes and recesses with a suitable nonmetallic brush. Flat, wood-backed brushes with soft fiber are recommended for surfaces; round brushes, similar to those used for washing bottles and test tubes, are recommended for holes and recesses.
- (3) Raise the casting from the bath, and permit solvent to drain into bath.
- (4) Immerse in rinsing bath of cleaning solvent, rinse, and raise from bath. Position the casting to drain dry so that solvent is not trapped in holes or recesses. When practical positioning will not permit complete draining, use the air jet to blow out any trapped solvent.

Caution

To prevent corrosion, avoid touching with bare hands any machined or non-finished surfaces after cleaning.

(5) Dry in dust-free, dry area, or suitable enclosure. Radiant heat used in a ventilated enclosure is recommended for drying, particularly where atmospheric humidity is high.

(6) Apply a light coat of MIL-L-7870 lubricating oil to any bare steel surface immediately when dry.

g. Mechanical Metal Parts. The detached miscellaneous mechanical metal parts include mounting plates, mounting clamps and brackets, nuts, bolts, screws, washers, handles, fasteners, and hardware. These should be cleaned in suitable cleaning machine or according to applicable steps of procedures for covers (d above).

h. Molded Plastic Parts. Plastic parts include insulating members, spacers, mounting blocks, etc. Clean these as follows:

- (1) Blow loose dust and dirt from surfaces, holes, and crevices with an air jet.
- (2) Wipe clean using a solvent-moistened, lint-free cloth.
- (3) Dry and polish with a clean, dry, lint-free cloth.

i. Printed Circuit Boards.

- (1) Blow and brush dust and dirt from surfaces, holes, and crevices using an air jet and a small camel's-hair brush.
- (2) Wipe clean using a lint-free cloth slightly moistened with solvent.

CAUTION

The epoxy moisture sealant on the etched circuit boards is susceptible to softening if solvent is applied for excessive periods of time or if an excessive amount of solvent is used. Be careful when cleaning these printed circuits with solvent. Dry with a clean, lint-free cloth immediately after cleaning with solvent-moistened cloth.

j. Switches, Wafer. Clean switches of the **phenolic wafer type on follows:**

- (1) Remove all dust with the air jet, rotating switch rotor back and forth several times while blowing.
- (2) Wash all contacts and insulation with solvent lightly applied with a small, camel's-hair brush.
- (3) Dry with the air jet; then repeat wash using clean solvent and rotating switch rotor.

k. Gaskets, Rubber.

- (1) Remove any grease from surfaces with a dry, lint-free cloth.
- (2) Make up a washing bath of 2 ounces of detergent powder per gallon of water.
- (3) Immerse gaskets and seals in bath, and wash clean with lint-free cloth.
- (4) Rinse well in clean, warm water, dry with the air jet. Protect from dust, lubricants, and high temperatures before inspection.

6-8. Inspection of Mechanical Parts

a. Introduction. This paragraph contains instructions and procedures to assist in determining (by inspection) the condition of the dismantled, disassembled, and cleaned components, assemblies, and parts of the 878L-15/16/17 module testers. Defects resulting from wear, physical damage, deteriorations, or other causes are brought to light by these inspection procedures. To facilitate inspection, detailed inspection procedures are arranged alphabetically under mechanical and electrical headings. Wherever possible, inspection procedures are listed in tabular form.

b. Inspection Procedures. This paragraph contains **routine inspection procedures.**

(1) Chassis. Inspect chassis for deformation, dents, punctures, badly worn surfaces, damaged connectors, damaged fastener devices, or damaged handles. Also inspect them for corrosion and damage to finish that will require refinishing.

(2) Covers. Inspect covers and shields for punctures, deep dents, and badly worn surfaces. Also check for damaged fastener devices, corro-

sions, and damage to finish that will require refinishing.

(3) **Gaskets, rubber.** Inspect gaskets and seals for deformation and for damage such as tears, creases, folds or elongation, rough surfaces, and embedded foreign matter. Check for loss of resiliency by moderately stretching or compressing and noting any failure to return to shape.

(4) **Machined metal parts.**

(a) Make overall check for physical damage to surfaces, corners, and edges.

(b) Inspect closely all machined plane surfaces, holes, bores, counterbores, slots, grooves, shoulders, flanges, teeth, tapped holes, and all threaded members, both male and female, for physical damage of any sort, including roughness of surface, corrosion, or presence of foreign matter.

(5) **Mechanical metal parts.** Inspect the unmachined mechanical parts (ventilating grilles, mounting plates, chassis, mounting clamps and brackets, nuts, bolts, screws, washers, handles, fasteners, and hardware) for physical damage or deformation. Also check for corrosion and any damage which would require replating or refinishing beyond practical touchup.

(6) **Molded plastic parts.** Inspect plastic parts (terminal boards, mounting blocks, and insulating members) for signs of corrosion, cracked or charred insulation, an? loose or missing mounting hardware. Also check for other abnormal indications which might be a source of future breakdown

6-9. Inspection of, Electrical, or Electronic

Components

a. **Capacitors, Fixed.** Inspect fixed capacitors for defects listed in table 6-11.

Table 6-11. Inspection of Fired Capacitors

Defect	Metal case	Molded type	Ceramic type
Oil leakage (at case seams or around terminal insulation).	X		
Cracked, broken, or charred terminal insulation.	X		
Case damage (dents or holes).	X		
Case damage (cracks or breakage).		X	
Body damage (cracks or breakage).			X
Loose, broken, or corroded terminal studs, lugs, or leads.	X	X	X
Loose, broken, or improperly soldered terminal connections.	X	X	X
Loose mountings.	I X	i x	x

b. **Capacitors, Variable.** Inspect variable capacitors for corrosion of shafts, cases, and other visible parts, loose mountings, and physical damage. Rotate the shaft to determine whether action is too rough, too loose, or too tight.

c. **Coils** Inspect coils for broken leads, loose, broken, or poorly soldered terminal connections, and loose mounting. Also check for crushed, scratched, cut or charred windings, leads, and terminal connections. Check for physical damage to forms and tuning slug adjustments, where applicable.

d. **Connections.** Inspect connector bodies for broken parts, deformed shells or clamps, and other irregularities. Inspect for cracked or broken insulation and for contacts that are broken, deformed, or out of alignment. Also check for corroded or damaged plating on contacts and for loose, poorly soldered, broken, or corroded terminal connections.

e. **Jacks.** Inspect all jacks for corrosion, rust, loose or broken parts, cracked insulation, bad contacts, and other irregularities.

f. **Printed Circuit Boards.**

(1) Inspect for loose, broken, corroded, or poorly soldered terminal connections.

(2) Inspect printed circuits for any evidence of damage, such as burned, broken, cracked, or corroded plating.

(3) Inspect printed circuit connectors for peeling, shavings, scarred, or corroded connector terminals.

(4) Inspect for complete moisture sealant coating of printed circuit boards.

(5) Inspect for loose mounting of printed circuit boards.

g. **Resistors, Fixed Composition.** Inspect these resistors for cracked, broken, blistered, or charred bodies and loose, broken, poorly soldered, or corroded terminal connections.

h. **Resistors, Fixed Wire-wound.** Inspect these resistors for signs of heating, cracked, broken, or charred insulation, loose, poorly soldered, broken, or corroded terminal connections, and loose mounting.

i. **Resistors, Variable.** Inspect variable resistors for corrosion of shafts, cases, and other visible parts, loose mountings, and physical damage. Rotate the shaft, where possible, to determine whether the action is too rough, too loose, or too tight.

j. **Switches, Wafer.**

(1) Inspect insulation for cracks or breakage and for charring.

(2) Check movable and stationary contacts

for deformities, breakage, and wear and for burning, pitting, or corrosion.

(3) Inspect terminals for loose, poorly soldered, broken, or corroded connections.

(4) Examine mechanical parts for damage or corrosion and for irregular or rough action.

k. Terminal Connections, Soldered.

(1) Inspect for cold-soldered or rosin joints. These joints present a porous, dull, rough, appearance. Check for strength of bond using the point of a tool.

(2) Examine for excess solder, protrusions from the joint, pieces adhering to adjacent insulation, and particles lodged between joints, conductor, or other parts.

(3) Inspect for insufficient solder and unsoldered strands of wire protruding from con-

ductor at joint. Look for insulation that is stripped back too far from joint or badly frayed joint.

(4) Inspect for corrosion (verdigris) on copper conductor at joint.

E. Transformers. Check all parts for signs of excessive heating, physical damage to case, cracked or broken ceramic insulators, and other irregularities. Also check for corroded, poorly soldered, or loose terminals and loose, broken or missing mounting hardware.

m. Wiring. Inspect open and laced wiring of chassis, terminal boards, and parts of equipment by checking insulation for physical damage and charring. Check wires for breakage and for improper dress in relation to adjacent wiring and chassis.

A P P E N D I X A

R E F E R E N C E S

Following is a list of references available to the direct and general support and depot maintenance repairman of the radio set:

DA Pam 310-4	Index of Technical Manuals, Technical Bulletins, Supply Manuals (Types 7, 8, and 9), Supply Bulletins, and Lubrication Orders.
DA Pam 310-7	Military Publications: Index of Modification Work Orders,
TB 43-0118	Field Instructions for Painting and Preserving Electronics Command Equipment.
TM 11-5821-248-35	DS, GS, and Depot Maintenance Manual: Radio Set AN/ARC-102.
TM 11-5985-326-20	Organizational Maintenance Manual: Coupler, Antenna CU-1658/A and CU-1669/GRC.
TM 11-6625-209-15	Operator's, Organizational, DS, GS, and Depot Maintenance Manual, Multimeters ME-26A/U, ME-26B/U, ME-26C/U, and ME-26D/U.
TM 11-6625-261-12	Operator's and Organizational Maintenance Manual: Audio Oscillators TS-382A/U, TS-382B/U, TS-382D/U, TS-382E/U, and TS-382F/U.
TM 11-6625-366-15	Operator's, Organizational, DS, GS, and Depot Maintenance Manual: Multimeter TS-352B/U.
TM 11-6625-438-15	Organizational, Direct Support, General Support, and Depot Maintenance Manual: Voltmeter, Electronic AN/USM-98.

APPENDIX C

MAINTENANCE ALLOCATION

Section I. INTRODUCTION

C - 1 . G e n e r a l

This appendix provides a summary of the maintenance operations for the AN/ARM-log. It authorizes categories of maintenance for specific maintenance functions on reparable items and components and the tools and equipment required to perform each function. This appendix may be used as an aid in planning maintenance operations.

C-2. Maintenance Function

Maintenance functions will be limited to and defined as follows:

a. **Inspect.** To determine the serviceability of an item by comparing its physical, mechanical, and/or electrical characteristics with established standards through examination.

b. **Test.** To verify serviceability and to detect incipient failure by measuring the mechanical or electrical characteristics of an item and comparing those characteristics with prescribed standards.

c. **Service.** Operations required periodically to keep an item in proper operating condition, i.e., to clean, preserve, drain, paint, or to replenish fuel/lubricants-hydraulic fluids or compressed air supplies.

d. **Adjust.** Maintain within prescribed limits by bringing into proper or exact position, or by setting the operating characteristics to the specified parameters.

e. **Align.** To adjust specified variable elements of an item to about optimum or desired performance.

f. **Calibrate.** To determine and cause corrections to be made or to be adjusted on instruments or test measuring and diagnostic equipment used in precision measurement. Consists of the comparison of two instruments, one of which is a certified standard of known accuracy, to detect and adjust any discrepancy in the accuracy of the instrument being compared.

g. **Install.** The act of emplacing, seating, or fixing into position an item, part, module (component or assembly) in a manner to allow the proper functioning of the equipment/system.

h. **Replace.** The act of substituting a service-

able like-type part, subassembly, model (component or assembly) for an unserviceable counterpart.

i. **Repair.** The application of maintenance services (inspect, test, service, adjust, align, calibrate, replace) or other maintenance actions (welding, grinding, riveting, straightening, facing, remachining, or resurfacing) to restore serviceability to an item by correcting specific damage, fault, malfunction, or failure in a part, subassembly, module/component/assembly, end item or system. This function does not include the trial and error replacement of running spare type items such as fuses, lamps, or electron tubes.

j. **Overhaul.** That periodic maintenance effort (service/action) necessary to restore an item to a completely serviceable/operational condition as prescribed by maintenance standards (e.g., DMWR) in appropriate technical publications. Overhaul is normally the highest degree of maintenance performed by the Army. Overhaul does not normally return an item to like-new condition.

k. **Rebuild.** Consists of those services/actions necessary for the restoration of unserviceable equipment to a like-new condition in accordance with original manufacturing standards. Rebuild is the highest degree of material maintenance applied to Army equipment. The rebuild operation includes the act of returning to zero those age measurements (hours, miles, etc.) considered in classifying Army equipment/components.

C - 3 . C o l u m n E n t r i e s

a. **Column 1, Group Number.** Column 1 lists group numbers, the purpose of which is to identify components, assemblies, subassemblies and modules with the next higher assembly.

b. **Column 2, Component/Assembly.** Column 2 contains the noun names of components, assemblies, subassemblies, and modules for which maintenance is authorized.

c. **Column 3, Maintenance Functions.** Column 3 lists the functions to be performed on the item listed in column 2. When items are listed with-

out maintenance functions, it is solely for purpose of having the group numbers in the MAC and RPSTL coincide.

d. Column 4, Maintenance Category. Column 4 specifies, by the listing of a "worktime" figure in the appropriate subcolumn(the lowest level of maintenance authorized to perform the function listed in column 3. This figure represents the active time required to perform that maintenance function at the indicated category of maintenance. If the number or complexity of the tasks within the listed maintenance function vary at different maintenance categories, appropriate "worktime" figures will be shown for each category. The number of man-hours specified by the "worktime" figure represents the average time required to restore an item (assembly, subassembly, component, module, end item or system) to a serviceable condition under typical field operating conditions. This time includes preparation time, troubleshooting time and quality assurance/quality control time in addition to the time required to perform the specific tasks identified for the maintenance functions authorized in the maintenance allocation chart. Subcolumns of column 4 are as follows:

- C-Operator/Crew
- O-Organizational
- F-Direct Support

H-General Support.

D-Depot

e. Column 5, Tools and Equipment. Column 5 specifies by code, those common tool sets (not individual tools) and special tools, test, and support equipment required to perform the designated function.

C-4. Tools and Equipment Requirements

(T a b l e 1)

a. Tool or Test Equipment Reference Code. The numbers in this column coincide with the numbers used in the tools and equipment column of the MAC. The numbers indicate the applicable tool or test equipment for the maintenance functions.

b. Maintenance Category. The codes in this column indicate the maintenance category allocated the tool or test equipment.

c. Nomenclature. This column lists the noun name and nomenclature of the tools and test equipment required to perform the maintenance functions.

d. National/NTAO Stock Number. The column lists the National/NATO stock number of the specific tool or test equipment.

e. Tool Number. This column lists the manufacturer's part number of the tool followed by the Federal Supply Code for manufacturers (5-digit) in parentheses.

Section II. MAINTENANCE ALLOCATION CHART
FOR
TEST SET, ANTENNA COUPLER AN/ARM-109

(1) GROUP NUMBER	(2) COMPONENT ASSEMBLY	(3) MAINTENANCE FUNCTION	(4) MAINTENANCE CATEGORY					(5) TOOLS AND EQUIPMENT
			C	O	F	H	D	
00	TEST SET, ANTENNA COUPLER AN/ARM-109	Inspect ¹ Test ² Replace Repair		0.1 0.2 0.2		1.0		1,2 1,2 3 thru 8
01	ANTENNA COUPLER CONTROL TESTER TS-2353/ARM-109 (Collins p/n 878L-15)	Inspect ¹ Test Replace Repair		0.2 0.2 0.2		0.6		1, 2 3 thru 9 1,2 3 thru 8
02	CONTROL, AMPLIFIER ELEC. TS-2354/ARM-109 (Collins p/n 878L-16)	Inspect ¹ Test Replace Repair		0.2 0.2 0.2		1.2 1.0	4.0	1,2 3 thru 14 1,2 3 thru 8 3 thru 14
03	DISCRIMINATOR TESTER TS-2352/ARM-109 (Collins p/n 87L-17)	Inspect ¹ Test Replace Repair		0.2 0.2 0.2		0.6 1.0		1,2 3 thru 14 1,2 3 thru 14
04	CABLES AND CONNECTORS	Inspect ¹ Test ² Replace ³ Repair		0.2 0.1 0.2		1.0	4.0	1,2 1,2 3 thru 14 3,4,5

1. Visual inspection of equipment to determine maintenance in regards to cleaning, painting, external mechanical and electrical damage.
 2. Equipment operation check and electrical continuity check.
 3. Organizational refers to externally replacing fuses, lamps, and external connections, and cables.
 4. Limited to component replacement.

TABLE 1. TOOL AND TEST EQUIPMENT REQUIREMENTS
FOR
TEST SET, ANTENNA COUPLER AN/ARM-109

Tool or Test EQUIPMENT REF CODE	MAINTENANCE CATEGORY	NOMENCLATURE	NATIONAL NATO STOCK NUMBER	TOOL NUMBER
1	0	MULTIMETER AN/URM-105	6625-00-581-2036	
2	0	TOOL KIT, ELECTONIC EQUIPMENT TK-101/G	5180-00-064-5178	
3	F,H,D	TOOL KIT, ELECTRONIC EQUIPMENT TK-100/G	5180-00-605-0079	
L	H,D	VOLTMETER, ELECTRONIC AN/USM-98	6625-00-753-2115	
5	H,D	MULTIMETER TS-352/U	6625-00-242-5023	
6	H,D	BRIDGE-CAPACITANCE. INDUCTANCE RESISTANCE AN/URM-90	6625-00-534-7458	
7	H,D	COUNTER, ELECTONIC DIGITAL READOUT AN/USM-207A	6625-00-044-3225	
8	H,D	TEST SET, TRANSISTOR TS-1836A	6625-00-893-2628	
9	H,D	MULTIMETER ME-26B/U	6625-00-542-6407	
10	O,F,H,D	CABLE CX-10735/U	6625-00-435-2638	
11	H,D	ANTENNA COUPLER CONTROL (Collins 528-0465-000)	5821-00-043-1990	
12	H,D	RECEIVER-TRANSMITTER RT-698/ARC-102	5821-00-604-3307	
13	H,D	RADIO SET, CONTROL C-3940/ARC-94	5821-00-953-2204	
14	H,D	METER TESTER TS-656/U	6625-00-348-0666	

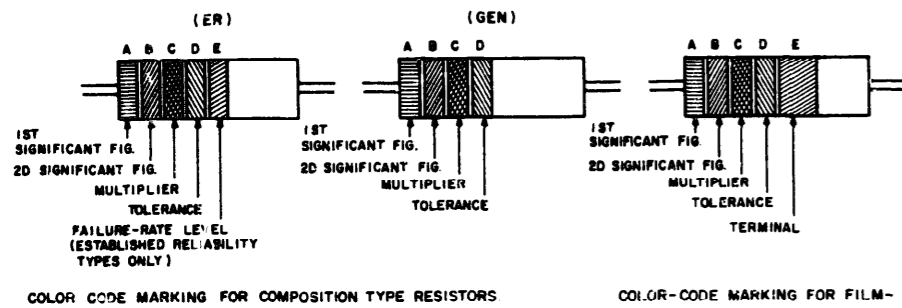

TABLE 1
COLOR CODE FOR COMPOSITION TYPE AND FILM TYPE RESISTORS.

BAND A		BAND B		BAND C		BAND D		BAND E	
COLOR	FIRST SIGNIFICANT FIGURE	COLOR	SECOND SIGNIFICANT FIGURE	COLOR	MULTIPLIER	COLOR	RESISTANCE TOLERANCE (PERCENT)	COLOR	FAILURE RATE LEVEL
BLACK	0	BLACK	0	BLACK	1			BROWN	M=1.0
BROWN	1	BROWN	1	BROWN	10			RED	P=0.1
RED	2	RED	2	RED	100			ORANGE	R=0.01
ORANGE	3	ORANGE	3	ORANGE	1,000			YELLOW	S=0.001
YELLOW	4	YELLOW	4	YELLOW	10,000	SILVER	±10 (COMP. TYPE ONLY)	WHITE	
GREEN	5	GREEN	5	GREEN	100,000	GOLD	±5		
BLUE	6	BLUE	6	BLUE	1,000,000	RED	±2 (NOT APPLICABLE TO ESTABLISHED RELIABILITY)		
PURPLE (VIOLET)	7	PURPLE (VIOLET)	7						
GRAY	8	GRAY	8	SILVER	0.01				
WHITE	9	WHITE	9	GOLD	0.1				SOLDERABLE

- BAND A — THE FIRST SIGNIFICANT FIGURE OF THE RESISTANCE VALUE (BANDS A THRU D SHALL BE OF EQUAL WIDTH.)
- BAND B — THE SECOND SIGNIFICANT FIGURE OF THE RESISTANCE VALUE.
- BAND C — THE MULTIPLIER (THE MULTIPLIER IS THE FACTOR BY WHICH THE TWO SIGNIFICANT FIGURES ARE MULTIPLIED TO YIELD THE NOMINAL RESISTANCE VALUE.)
- BAND D — THE RESISTANCE TOLERANCE.
- BAND E — WHEN USED ON COMPOSITION RESISTORS, BAND E INDICATES ESTABLISHED RELIABILITY FAILURE-RATE LEVEL (PERCENT FAILURE PER 1,000 HOURS). ON FILM RESISTORS, THIS BAND SHALL BE APPROXIMATELY 1-1/2 TIMES THE WIDTH OF OTHER BANDS, AND INDICATES TYPE OF TERMINAL.

RESISTANCES IDENTIFIED BY NUMBERS AND LETTERS (THESE ARE NOT COLOR CODED)

SOME RESISTORS ARE IDENTIFIED BY THREE OR FOUR DIGIT ALPHA NUMERIC DESIGNATORS. THE LETTER R IS USED IN PLACE OF A DECIMAL POINT WHEN FRACTIONAL VALUES OF AN OHM ARE EXPRESSED. FOR EXAMPLE:

2R7 = 2.7 OHMS 10R0 = 10.0 OHMS

FOR WIRE-WOUND-TYPE RESISTORS COLOR CODING IS NOT USED, IDENTIFICATION MARKING IS SPECIFIED IN EACH OF THE APPLICABLE SPECIFICATIONS.

EXAMPLES OF COLOR CODING

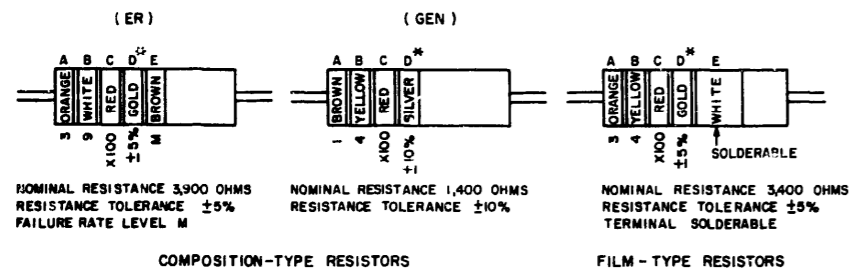

* IF BAND D IS OMITTED, THE RESISTOR TOLERANCE IS ±20% AND THE RESISTOR IS NOT MIL-STD.

A. COLOR CODE MARKING FOR MILITARY STANDARD RESISTORS.

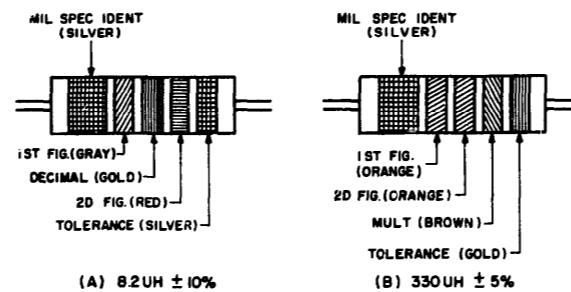

COLOR CODING FOR TUBULAR ENCAPSULATED R.F. CHOKES. AT A, AN EXAMPLE OF OF THE CODING FOR AN 8.2UH CHOKE IS GIVEN. AT B, THE COLOR BANDS FOR A 330UH INDUCTOR ARE ILLUSTRATED.

TABLE 2
COLOR CODING FOR TUBULAR ENCAPSULATED R.F. CHOKES.

COLOR	SIGNIFICANT FIGURE	MULTIPLIER	TOLERANCE (PERCENT)
BLACK	0	1	
BROWN	1	10	1
RED	2	100	2
ORANGE	3	1,000	3
YELLOW	4		
GREEN	5		
BLUE	6		
VIOLET	7		
GRAY	8		
WHITE	9		
NONE			20
SILVER			10
GOLD	DECIMAL POINT		5

MULTIPLIER IS THE FACTOR BY WHICH THE TWO COLOR FIGURES ARE MULTIPLIED TO OBTAIN THE INDUCTANCE VALUE OF THE CHOKE COIL.

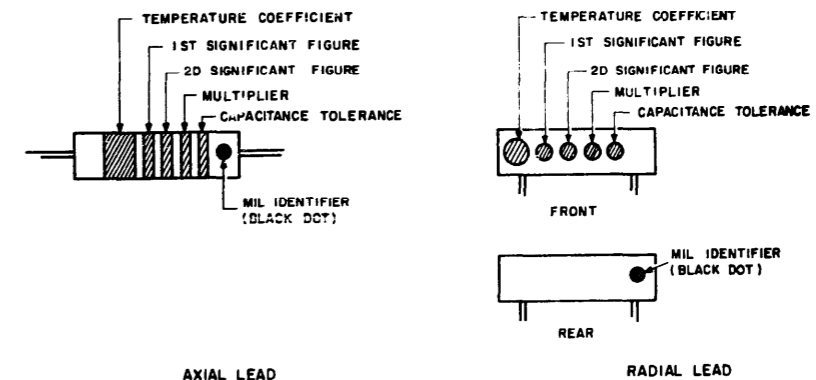
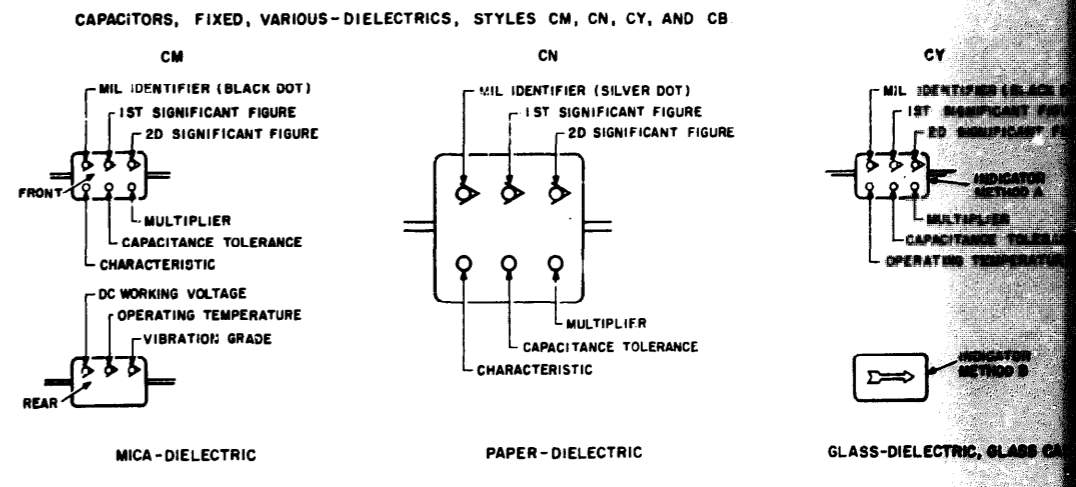

FO-1. Resistor, capacitor, and inductor codes.

C. COLOR

OS-DIELECTRICS, STYLES CM, CN, CY, AND CB.

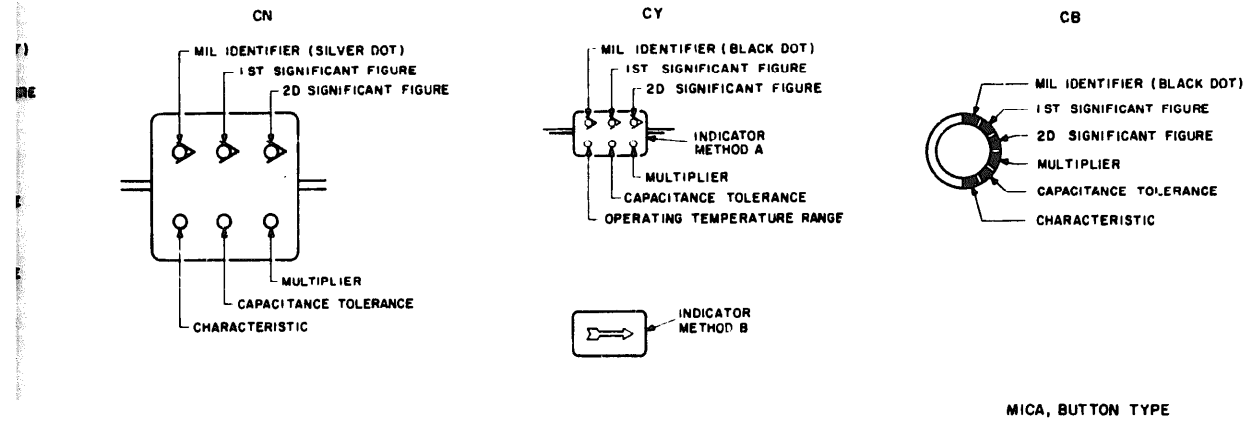

MICA, BUTTON TYPE

TABLE 3 - FOR USE WITH STYLES CM, CN, CY AND CB.

COLOR	MIL ID	1ST SIG FIG.	2D SIG FIG.	MULTIPLIER ¹	CAPACITANCE TOLERANCE				CHARACTERISTIC ²			DC WORKING VOLTAGE	OPERATING TEMP. RANGE	VIBRATION GRADE
					CM	CN	CY	CB	CM	CN	CB			
BLACK	CM, CY, CB	0	0	1			±20%	±20%		A			-55° TO +70°C	10-55 HZ
BROWN		1	1	10						B	E	B		
RED		2	2	100	±2%		±2%	±2%		C			-55° TO +85°C	
ORANGE		3	3	1,000		±30%				D		D	300	
YELLOW		4	4	10,000						E			-55° TO +125°C	10-2,000 HZ
GREEN		5	5		±5%					F			500	
BLUE		6	6										-55° TO +150°C	
PURPLE (VIOLET)		7	7											
GRAY		8	8											
WHITE		9	9											
GOLD				0.1			±5%	±5%						
SILVER	CN			0.01	±10%	±10%	±10%	±10%						

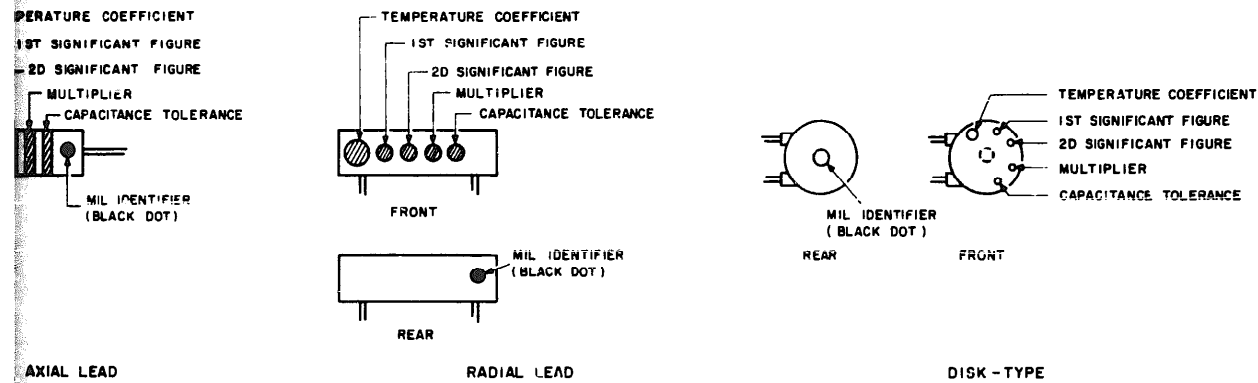
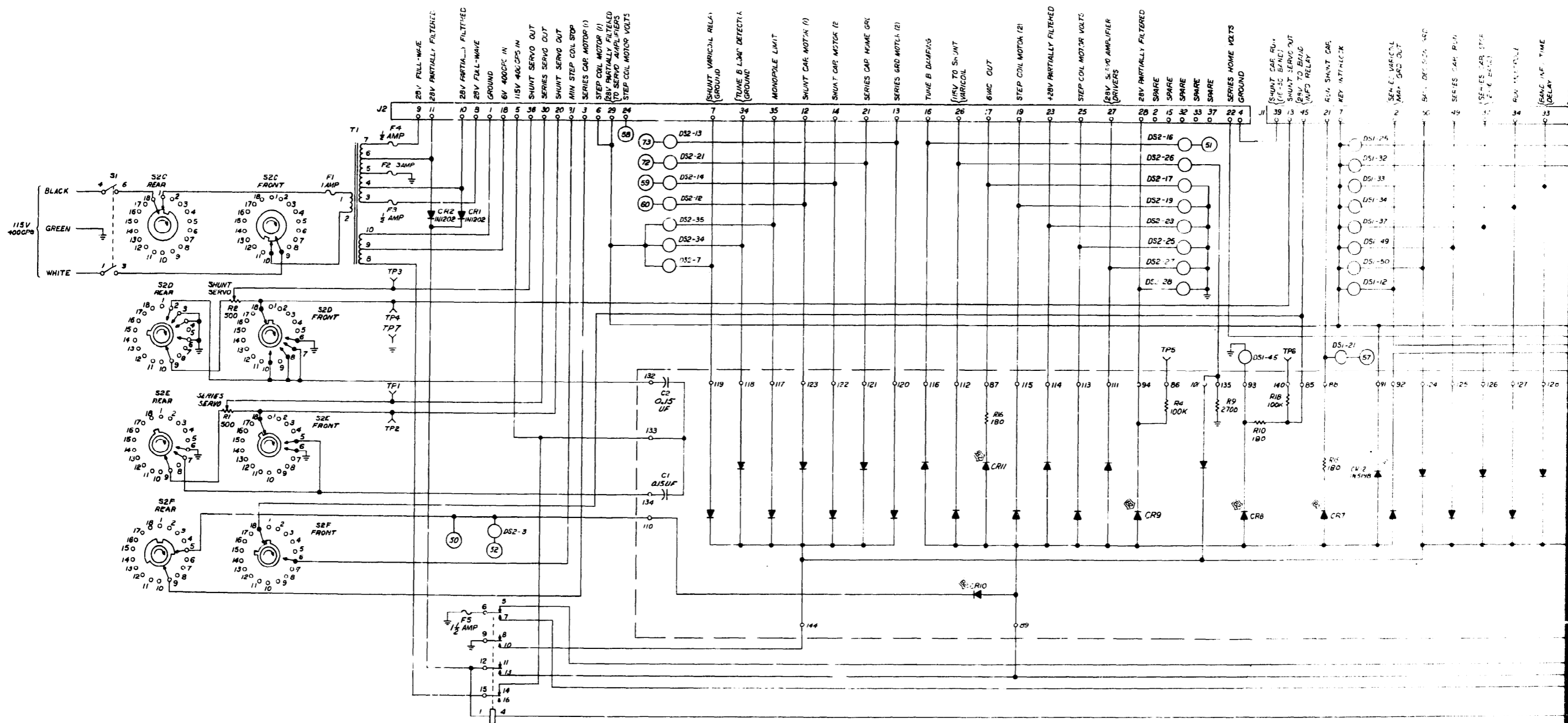

TABLE 4 - TEMPERATURE COMPENSATING, STYLE CC.

COLOR	TEMPERATURE COEFFICIENT ⁴	1ST SIG FIG.	2D SIG FIG.	MULTIPLIER ¹	CAPACITANCE TOLERANCE		MIL ID
					CAPACITANCES OVER 10 UUF	CAPACITANCES 10 UUF OR LESS	
BLACK	0	0	0	1		± 2.0 UUF	CC
BROWN	-30	1	1	10	±1%		
RED	-80	2	2	100	±2%	± 0.25 UUF	
ORANGE	-150	3	3	1,000			
YELLOW	-220	4	4				
GREEN	-330	5	5		± 5%	± 0.5 UUF	
BLUE	-470	6	6				
PURPLE (VIOLET)	-750	7	7				
GRAY		8	8	0.01*			
WHITE		9	9	0.1*	± 10%		
GOLD	+100			0.1		± 1.0 UUF	
SILVER				0.01			

1. THE MULTIPLIER IS THE NUMBER BY WHICH THE TWO SIGNIFICANT (SIG) FIGURES ARE MULTIPLIED TO OBTAIN THE CAPACITANCE IN UUF.
 2. LETTERS INDICATE THE CHARACTERISTICS DESIGNATED IN APPLICABLE SPECIFICATIONS: MIL-C-5, MIL-C-25D, MIL-C-11272B, AND MIL-C-10950C RESPECTIVELY.
 3. LETTERS INDICATE THE TEMPERATURE RANGE AND VOLTAGE-TEMPERATURE LIMITS DESIGNATED IN MIL-C-11015D.
 4. TEMPERATURE COEFFICIENT IN PARTS PER MILLION PER DEGREE CENTIGRADE.
- * OPTIONAL CODING WHERE METALLIC PIGMENTS ARE UNDESIRABLE.



FO-2.1. 878L-15 Antenna Coupler Control Tester, Schematic diagram (Sheet 1 of 2)

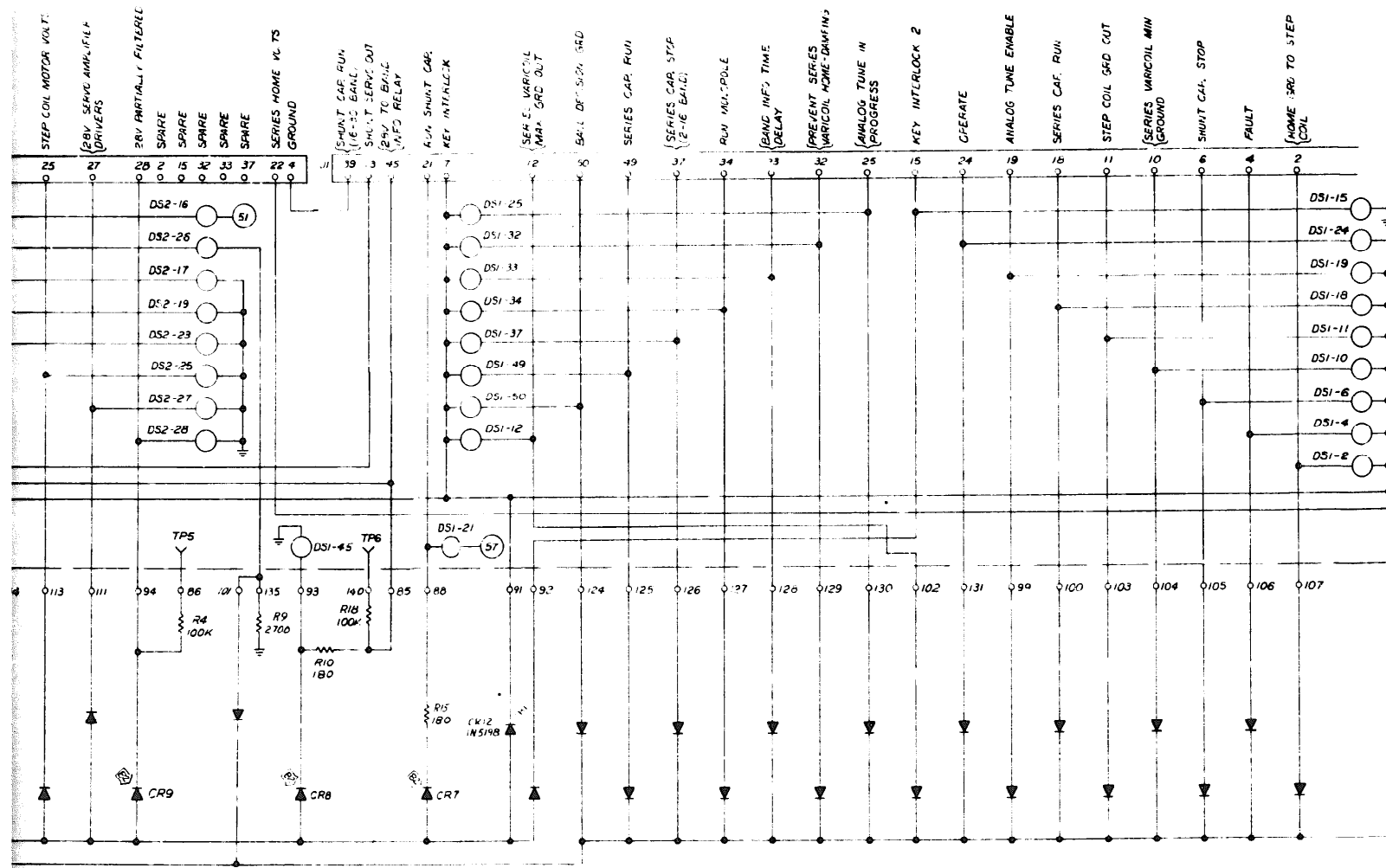

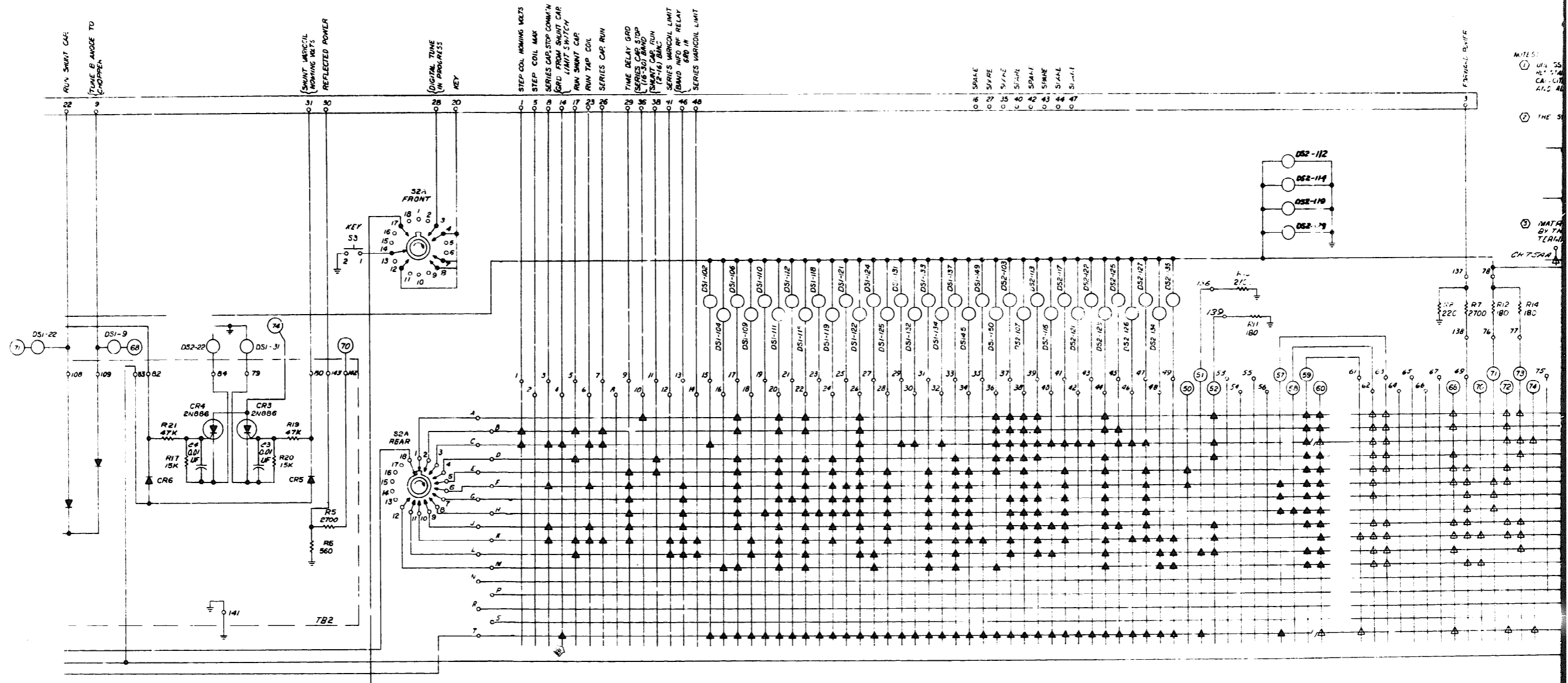

FO-2.2. 878L-15 Antenna Coupler Control Tester, Schematic Diagram (sheet 2 of 2).

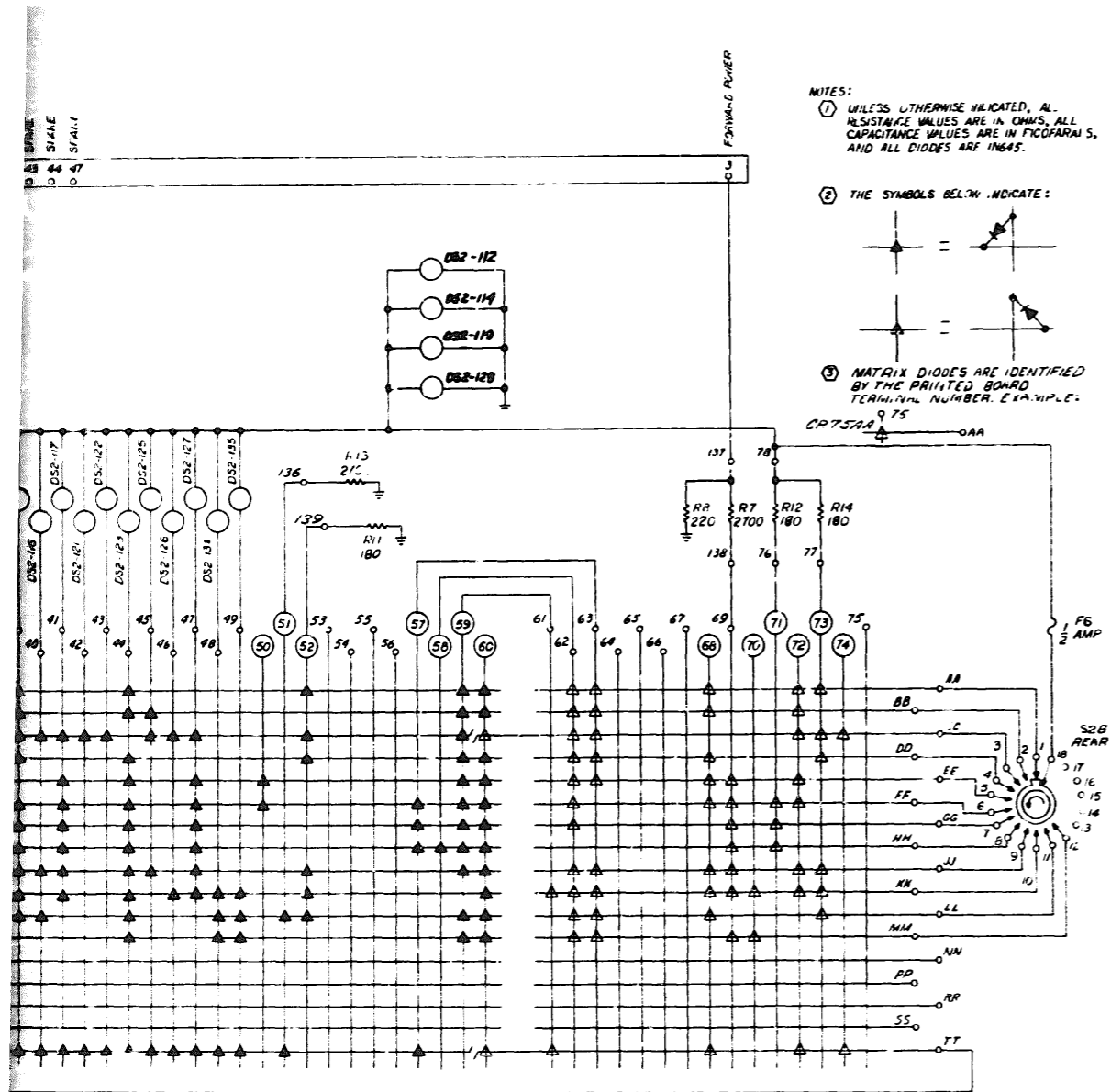

④ INDICATORS DS1-21, DS1-22, DS2-3, DS2-13 AND DS2-17 ARE 382 LAMPS (18 VOLTS); ALL OTHER INDICATORS ARE 385 LAMPS (28 VOLTS).

Schematic Diagram (sheet 2 of 2).

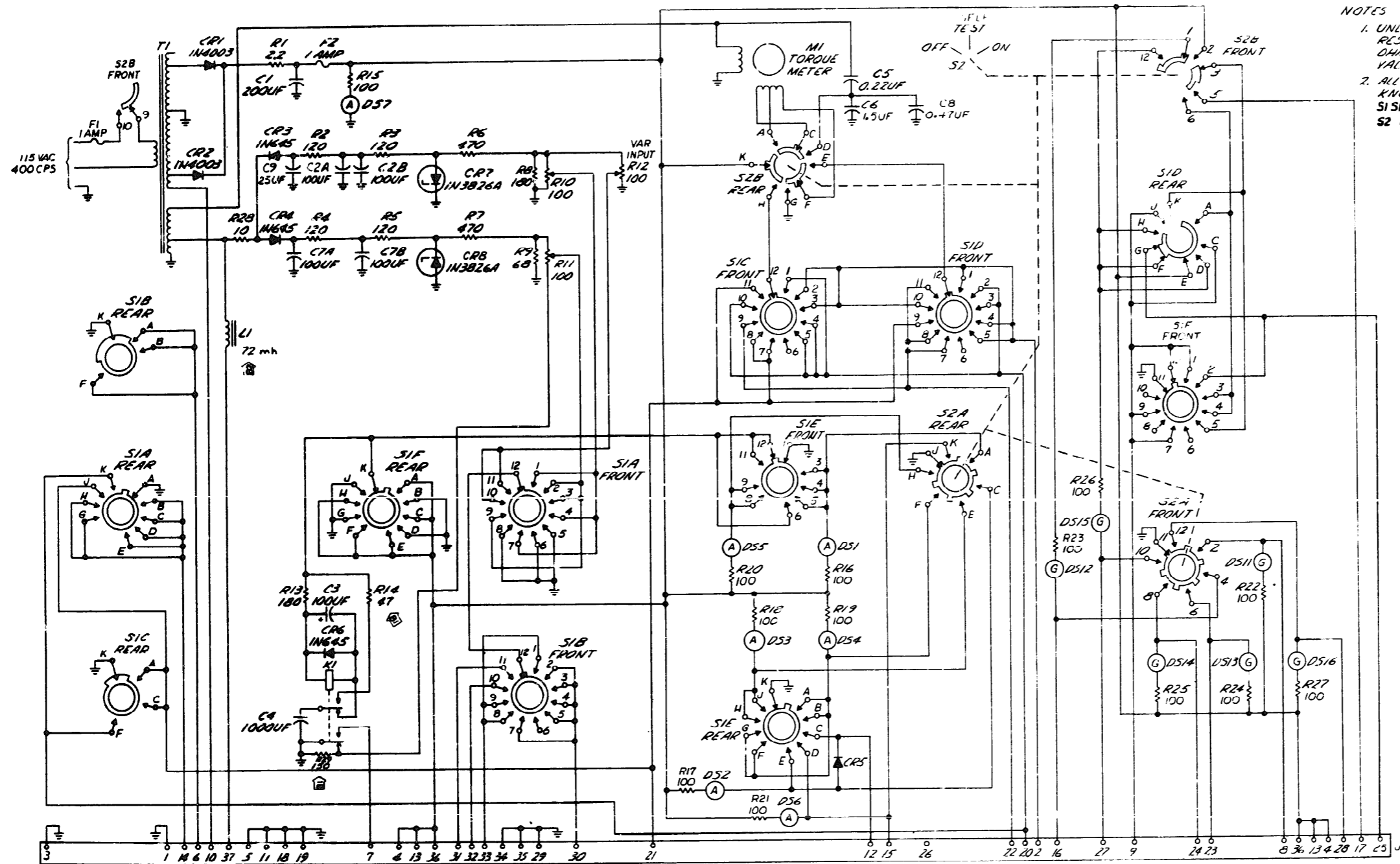

- NOTES
1. UNLESS OTHERWISE INDICATED RESISTANCE VALUES ARE IN OHMS AND CAPACITANCE VALUES ARE IN MICROFARADS.
 2. ALL SWITCHES VIEWED FROM KNOB OR DRIVEN END. S1 SHOWN IN POSITION 12. (OFF) S2 SHOWN IN POSITION 1. (OFF)

FO-3. 878L-16 Electronic Control Amplifier Tester, Schematic Diagram.

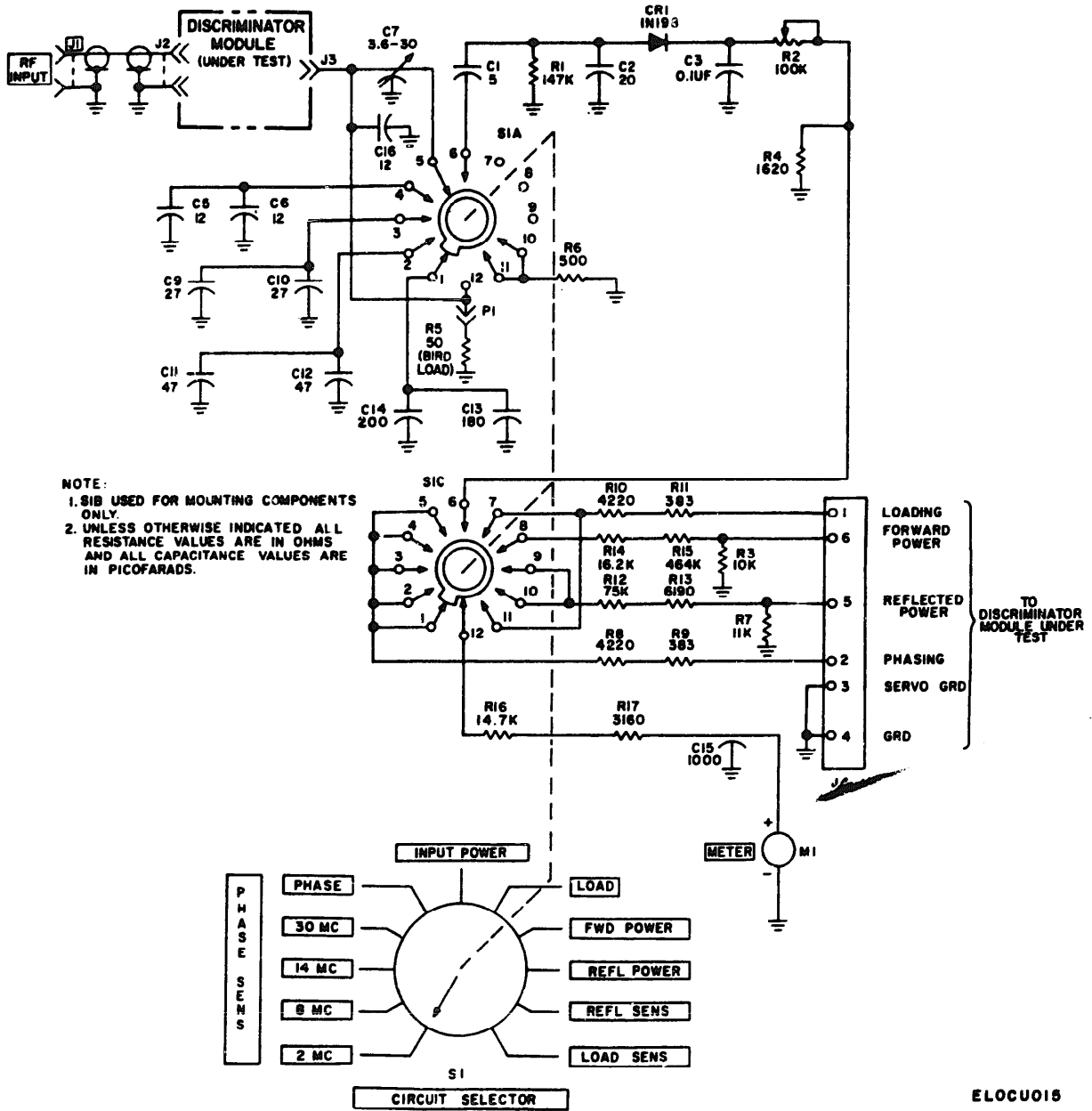

ELOCU015

FO-4.878L-17 Discriminator Tester, Schematic Diagram.

RECOMMENDED CHANGES TO EQUIPMENT TECHNICAL MANUALS



SOMETHING WRONG WITH THIS MANUAL?

THEN... JOT DOWN THE DOPE ABOUT IT ON THIS FORM, TEAR IT OUT, FOLD IT AND DROP IT IN THE MAIL!

FROM: (YOUR UNIT'S COMPLETE ADDRESS)

Commander
Stateside Army Depot
ATTN: AMSTA-US
Stateside, N.J. 07703

DATE 10 July 1975

PUBLICATION NUMBER TM 11-5840-340-12	DATE 23 Jan 74	TITLE Radar Set AN/P-3-76
---	-------------------	------------------------------

BE EXACT... PIN-POINT WHERE IT IS				IN THIS SPACE TELL WHAT IS WRONG AND WHAT SHOULD BE DONE ABOUT IT:
PAGE NO.	PARA-GRAPH	FIGURE NO.	TABLE NO.	
2-25	2-28			<p>Recommend that the installation antenna alignment procedure be changed throughout to specify a 2° IFF antenna lag rather than 1°.</p> <p>REASON: Experience has shown that with only a 1° lag, the antenna servo system is too sensitive to wind gusting in excess of 25 knots, and has a tendency to rapidly accelerate and decelerate as it hunts, causing strain to the drive train. Hunting is minimized by adjusting the lag to 2° without degradation of operation.</p>
3-10	3-3		3-1	<p>Item 5, Function column. Change "2 db" to "3db."</p> <p>REASON: The adjustment procedure for the TRANS POWER FAULT indicator calls for a 3 db (500 watts) adjustment to light the TRANS POWER FAULT indicator.</p>
5-6	5-8			<p>Add new step f.1 to read, "Replace cover plate removed in step e.1, above."</p> <p>REASON: To replace the cover plate.</p>
		FO3		<p>Zone C 3. On J1-2, change "+24 VDC to "+5 VDC."</p> <p>REASON: This is the output line of the 5 VDC power supply. + 24 VDC is the input voltage.</p>

TEAR ALONG DOTTED LINE

TYPED NAME, GRADE OR TITLE, AND TELEPHONE NUMBER SSG I. M. DeSpiritof 999-1776	SIGN HERE: <i>SSG I. M. DeSpiritof</i>
---	---

DA FORM 2028-2 (TEST) P.S.--IF YOUR OUTFIT WANTS TO KNOW ABOUT YOUR MANUAL "FIND" MAKE A CARBON COPY OF THIS AND GIVE IT TO YOUR HEADQUARTERS.

RECOMMENDED CHANGES TO EQUIPMENT TECHNICAL MANUALS



SOMETHING WRONG WITH THIS MANUAL?

THEN... JOT DOWN THE DOPE ABOUT IT ON THIS FORM, TEAR IT OUT, FOLD IT AND DROP IT IN THE MAIL!

FROM: (YOUR UNIT'S COMPLETE ADDRESS)

DATE

PUBLICATION NUMBER

DATE

TITLE

BE EXACT... PIN-POINT WHERE IT IS

IN THIS SPACE TELL WHAT IS WRONG AND WHAT SHOULD BE DONE ABOUT IT:

PAGE NO.	PARA-GRAPH	FIGURE NO.	TABLE NO.
----------	------------	------------	-----------

TEAR ALONG DOTTED LINE

TYPED NAME, GRADE OR TITLE, AND TELEPHONE NUMBER

SIGN HERE:

DA FORM 2028-2 (TEST)
1 AUG 74

P.S.--IF YOUR OUTFIT WANTS TO KNOW ABOUT YOUR MANUAL "FIND," MAKE A CARBON COPY OF THIS AND GIVE IT TO YOUR HEADQUARTERS.

FILL IN YOUR
UNIT'S ADDRESS

FOLD BACK

DEPARTMENT OF THE ARMY

POSTAGE AND FEES PAID
DEPARTMENT OF THE ARMY
DOD-314

OFFICIAL BUSINESS
PENALTY FOR PRIVATE USE, \$300

Commander
US Army Electronics Command
ATTN: DRSEL-MA-Q
Fort Monmouth, New Jersey 07703

FOLD BACK

TEAR ALONG DOTTED LINE

FILL IN YOUR
UNIT'S ADDRESS

FOLD BACK

DEPARTMENT OF THE ARMY

POSTAGE AND FEES PAID
DEPARTMENT OF THE ARMY
DD-314

OFFICIAL BUSINESS
PENALTY FOR PRIVATE USE, \$300

Commander
US Army Electronics Command
ATTN: DRSEL-MA-Q
Fort Monmouth, New Jersey 07703

TEAR ALONG DOTTED LINE

FOLD BACK

REVERSE OF DA FORM 2025-2 (TEST)

RECOMMENDED CHANGES TO EQUIPMENT TECHNICAL MANUALS



SOMETHING WRONG WITH THIS MANUAL?

THEN... JOT DOWN THE DOPE ABOUT IT ON THIS FORM, TEAR IT OUT, FOLD IT AND DROP IT IN THE MAIL!

FROM: (YOUR UNIT'S COMPLETE ADDRESS)

DATE

PUBLICATION NUMBER

DATE

TITLE

BE EXACT... PIN-POINT WHERE IT IS

IN THIS SPACE TELL WHAT IS WRONG AND WHAT SHOULD BE DONE ABOUT IT:

PAGE NO.	PARA-GRAPH	FIGURE NO.	TABLE NO.
----------	------------	------------	-----------

TEAR ALONG DOTTED LINE

TYPED NAME, GRADE OR TITLE, AND TELEPHONE NUMBER

SIGN HERE:

DA FORM 2028-2 (TEST)
1 AUG 74

P.S.--IF YOUR OUTFIT WANTS TO KNOW ABOUT YOUR MANUAL "FIND," MAKE A CARBON COPY OF THIS AND GIVE IT TO YOUR HEADQUARTERS.

FILL IN YOUR
UNIT'S ADDRESS

FOLD BACK

DEPARTMENT OF THE ARMY

POSTAGE AND PERG PAID
DEPARTMENT OF THE ARMY
000-814

OFFICIAL BUSINESS
PENALTY FOR PRIVATE USE, \$300

Commander
US Army Electronics Command
ATTN: DRSEL-MA-Q
Fort Monmouth, New Jersey 07703

FOLD BACK

TEAR ALONG DOTTED LINE

REVERSE OF DA FORM 2026-2 (TEST)

By Order of the Secretary of the Army:

FRED C. WEYAND
General, United States Army
Chief of Staff

Official:

PAUL T. SMITH
Major General, United States Army
The Adjutant General

Distribution:

To be distributed in accordance with DA Form 12-36A, (qty rqr block no. 816) Organizational maintenance requirements for AN/ARM-109.

DEPARTMENT OF THE ARMY
US ARMY AG PUBLICATIONS CENTER
1688 WOODSON ROAD
ST. LOUIS, MISSOURI 63114

OFFICIAL BUSINESS
PENALTY FOR PRIVATE USE \$300

POSTAGE AND FEES PAID
DEPARTMENT OF THE ARMY
DOD 314



END

8-1-83

DATE





DEPARTMENT OF THE ARMY

MICROFORM TEST TARGET

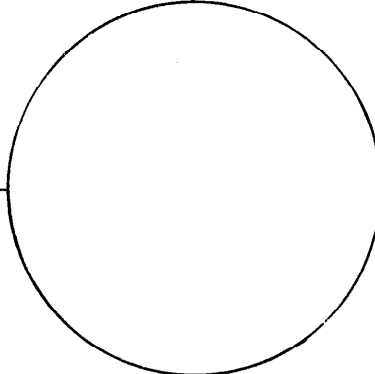
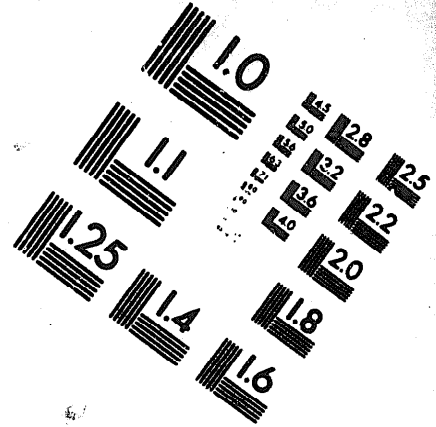
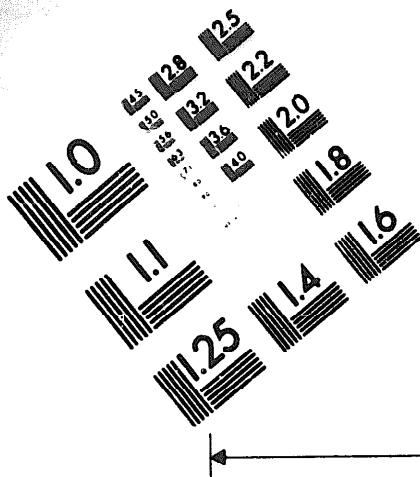

150 MM

1.0 mm (e= .81 mm)

ABCDEFGHIJKLMN O PQRSTU VWXYZ 1234567890
abcdefghijklmnopqrstuvwxyz \$%&' /%# 1/2 1/4 3/4 — = + x & @ *

1.5 mm (e= 1.09 mm)

ABCDEFGHIJKLMN O PQRSTU VWXYZ 1234567890
abcdefghijklmnopqrstuvwxyz \$%&' /%# 1/2 1/4 3/4 — = + x & @ *

2.0 mm (e= 1.37 mm)

ABCDEFGHIJKLMN O PQRSTU VWXYZ
abcdefghijklmnopqrstuvwxyz
1234567890 \$%&' /%# 1/2 1/4 3/4 — = + x & @ *

2.5 mm (e= 1.77 mm)

ABCDEFGHIJKLMN O PQRSTU VWXYZ
abcdefghijklmnopqrstuvwxyz
1234567890 \$%&' /%# 1/2 1/4 3/4 — = + x & @ *

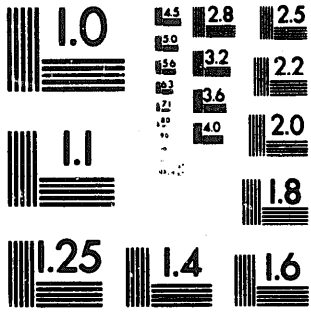

1.0 mm (e= .81 mm)

ABCDEFGHIJKLMN O PQRSTU VWXYZ 1234567890
abcdefghijklmnopqrstuvwxyz \$%&' /%# 1/2 1/4 3/4 — = + x & @ *

1.5 mm (e= 1.09 mm)

ABCDEFGHIJKLMN O PQRSTU VWXYZ 1234567890
abcdefghijklmnopqrstuvwxyz \$%&' /%# 1/2 1/4 3/4 — = + x & @ *

2.0 mm (e= 1.37 mm)

ABCDEFGHIJKLMN O PQRSTU VWXYZ
abcdefghijklmnopqrstuvwxyz
1234567890 \$%&' /%# 1/2 1/4 3/4 — = + x & @ *

2.5 mm (e= 1.77 mm)

ABCDEFGHIJKLMN O PQRSTU VWXYZ
abcdefghijklmnopqrstuvwxyz
1234567890 \$%&' /%# 1/2 1/4 3/4 — = + x & @ *

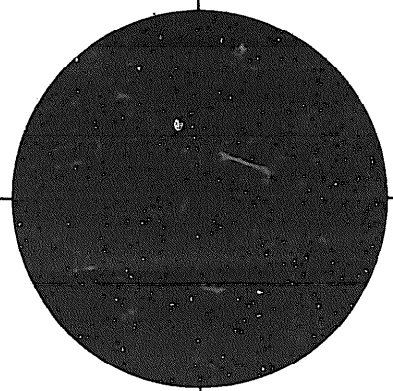

200 MM

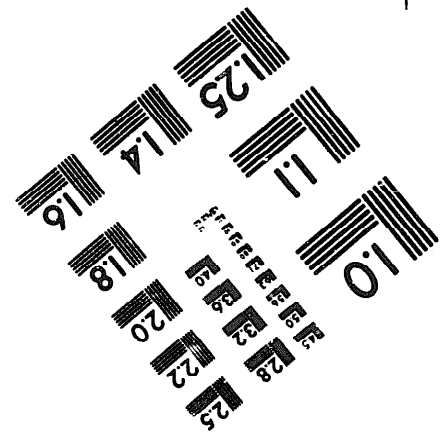
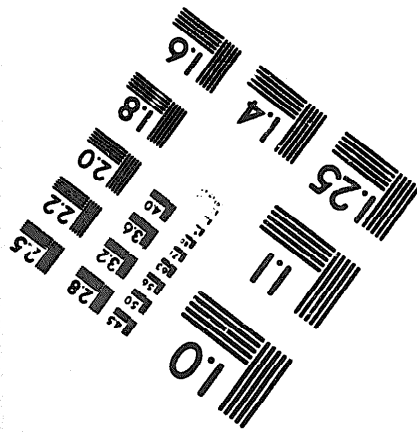

250 MM